

HI981520

Marine Monitor

pH

Marine Salinity

Temperature



Hanna® is committed to developing and deploying digital solutions with a positive impact on the environment and climate.



Please scan the QR code or follow the link to download the HI981520 user manual.
<https://manuals.hannainst.com/Hi981520>



Dear Customer,

Thank you for choosing a Hanna Instruments® product.

Please read this instruction manual carefully before using this instrument as it provides the necessary information for correct use of this instrument as well as a precise idea of its versatility.

If you need additional technical information, do not hesitate to e-mail us at tech@hannainst.com.

Visit www.hannainst.com for more information about Hanna Instruments and our products.

TABLE OF CONTENTS

1. Preliminary Examination	3
2. General Description & Intended Use	4
3. Specifications	5
3.1. Monitor	5
3.2. Probes	6
4. Functional & Keypad Description	7
5. Installation	8
6. Setup	10
7. Calibration	14
7.1. pH	14
7.2. Conductivity	16
7.3. Clear Calibration	17
8. Measurement	17
9. Maintenance & Care	18
10. Warnings & Errors	19
11. Accessories	19
Certification	20
Recommendations for Users	20
Warranty	20

*All rights are reserved. Reproduction in whole or in part is prohibited without the written consent of the copyright owner, Hanna Instruments Inc., Woonsocket, Rhode Island, 02895, USA.
Hanna Instruments reserves the right to modify the design, construction, or appearance of its products without advance notice.*

1. PRELIMINARY EXAMINATION

Remove the instrument and accessories from the packaging and examine it carefully. For further assistance, please contact your local Hanna Instruments office or email us at tech@hannainst.com.

Each **HI981520** is supplied with:

- **HI1286** pH electrode
- **Attached** conductivity and temperature probe
- pH 7.01 buffer solution, 20 mL sachet (2 pcs.)
- pH 10.01 buffer solution, 20 mL sachet (2 pcs.)
- 35.00 ppt salinity calibration solution, 20 mL sachet (2 pcs.)
- Electrode cleaning solution, 20 mL sachet (2 pcs.)
- Suction cup with clip (2 pcs.)
- Self-adhesive fastener (2 pcs.)
- 12 Vdc power adapter
- Probe quality certificate
- Quick reference guide with QR code for manual download and instrument quality certificate

Note: *Save all packing material until you are sure that the instrument works correctly. Any damaged or defective item must be returned in its original packing material with the supplied accessories.*

2. GENERAL DESCRIPTION & INTENDED USE

Testing and monitoring salinity in saltwater aquariums is an ongoing task.

The **HI981520** is a vertical-mount unit that monitors and displays the **conductivity** (measured with attached probe) and the **pH level** (replaceable pH electrode).

Each parameter can be configured for high/low operating mode and the results are displayed on a large, easy to read LCD.

The system can be calibrated at one or two points for pH and at one point for conductivity.

Seawater salinity is expressed in either parts per thousand (ppt), Practical Salinity Units (PSU), or Specific Gravity (S.G.).

ppt

Measurements expressed in ppt are based on the Natural Seawater Scale that extends from 0.00 to 80.00 g/L and covers 10 to 31 °C temperature range. It determines the salinity based upon a conductivity ratio of sample to standard seawater at 15 °C and an approximate salinity value of 35 in seawater.

PSU

The practical salinity of seawater relates the ratio of electrical conductivity of a normal seawater sample at 15 °C and 1 atmosphere to a potassium chloride solution (KCl) with a mass of 32.4356 g/Kg water at the same temperature and pressure. Under these conditions the ratio is equal to 1 and $S=35$. The practical salinity scale may be applied to values 0 through 42.00 psu at temperatures between 0 to 35 °C.

Specific Gravity (S.G.)

Specific Gravity, or relative density, is expressed as the ratio of the density of seawater, at a specific temperature, relative to the density of the same volume of pure water at a specific temperature.

The probes are **secured with suction cups** to the back of an aquarium (tank) and are suited for continuous measurement of conductivity and associated parameters required in applications such as seawater, saltwater aquariums, or aquaculture.

The distance between monitored sample and monitor unit extends to **2 m (6.6')** **probes cable** length.

The system is simple to install (self-adhesive or screw mount) and easy to setup and use.

Main Features

- Two Alarm operating modes (High/Low Value) for each supported parameter
- High/Low Alarm generated when measured value exceeds or drops below configured parameter High/Low Value
- Acoustic signal generated each time an alarm is triggered
- The EC probe contains an integral temperature sensor that simplifies installation
- All readings are compensated for variations in temperature
- Temperature is displayed in °C or °F along with pH and EC readings
- Easy to read LCD display

3. SPECIFICATIONS

3.1. MONITOR

pH	Range*	0.0 to 14.0 pH
	Resolution	0.1 pH
	Accuracy	± 0.2 pH
	Calibration	Manual or automatic two-point calibration in 7.01 and 10.01 pH
ppt	Range	0.0 to 70.0 ppt (g/L)
	Resolution	0.1 ppt (g/L)
	Accuracy	± 1.0 ppt between 0.0 ppt and 40.0 ppt ± 2.0 ppt between 40.0 ppt and 70.0 ppt
	Calibration	Automatic, single point in 35.00 ppt
PSU	Range	0.0 to 70.0 PSU
	Resolution	0.1 PSU
	Accuracy	± 1.0 PSU between 0.0 PSU and 40.0 PSU ± 2.0 PSU between 40.0 PSU and 70.0 PSU
S.G.	Range	1.000 to 1.041 S.G.
	Resolution	0.001 S.G.
	Accuracy	± 0.001 S.G.
Temperature	Range	0.0 to 50.0 °C (32.0 to 122.0 °F)
	Resolution	0.1 °C / 0.1 °F
	Accuracy	± 0.5 °C / ± 1.0 °F
	Compensation	Automatic, 5 to 50 °C (41 to 122 °F)
Alarm	pH	
	EC	High or Low with Enable or Disable option
	Temperature	
High/Low Value	with High/Low alarm Enabled	
Probes	pH	HI1286
	EC	Attached
Power supply	12 Vdc adapter (included) from 115 Vac, and 230 Vac	
Environment	0 to 50°C (32 to 122°F); RH max 95%, non-condensing	
Casing	IP65 ingress protection	
Dimensions	125 x 185 x 38 mm (4.92 x 7.28 x 1.49")	
Weight	300 g (10.6 oz)	

* The range may be limited by the probe's limits.

3.2. PROBES

HI1286 pH Electrode

Range	0 to 13 pH
Recommended operating temperature	0 to 80 °C (32 to 176 °F)
Body	PEI
Junction	PTFE
Reference	Double junction, Ag/AgCl
Electrolyte	Polymer
Tip	Spheric (Ø 7.5 mm / 0.29")
Outer diameter	12 mm (0.47")
Overall length	160 mm (6.29")
Maximum pressure	3 bar (44 psi)
Cable	Coaxial, 2 m (6.56')
Connection	BNC



The **PEI** (Polyetherimide) **resin body** is easy to clean and resistant to many aggressive chemicals.

The **porous PTFE** (Polytetrafluoroethylene) junction is equally resistant to aggressive chemicals.

The **double junction** design presents a silver-free electrolyte solution interacting with the sample, making the electrode less susceptible to clogging and guaranteeing a fast response and stable reading.

Attached EC & Temperature Probe

Range	0.0 to 70.0 ppt
	0.0 to 70.0 PSU
	1.000 to 1.041 S.G.
Recommended operating temperature	0 to 50 °C (32 to 122 °F)
Body	Polypropylene (PP)
Conductivity sensor	Material ABS
	Electrode Graphite
Temperature sensor	AISI 316 stainless steel
Outer diameter	12.50 mm (0.49")
Overall length	155 mm (6.10")
Maximum pressure	3 bar (44 psi)
Cable	Coaxial, 2 m (6.56')



Built-in **temperature sensor** at the tip of the EC sensor allows for rapid determination of the sample temperature and a high-accuracy temperature reading.





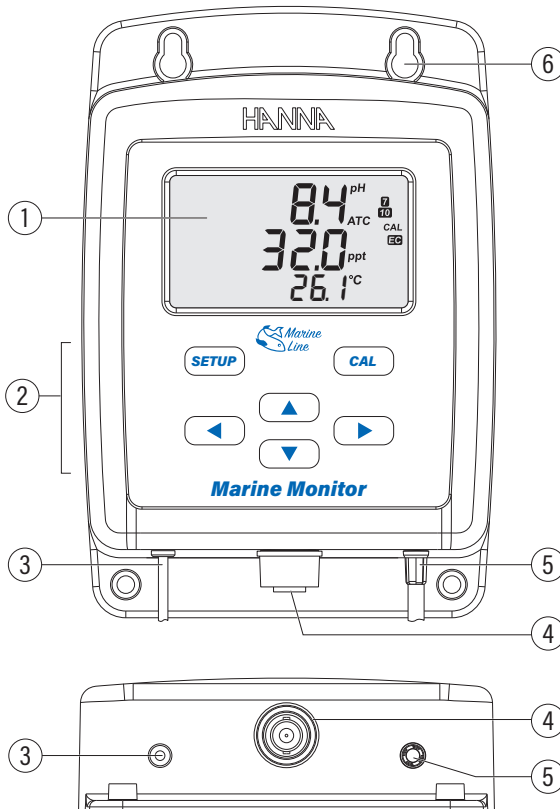

4. FUNCTIONAL & KEYPAD DESCRIPTION

Front & Rear View



- | | |
|---------------------------------|----------------------------------|
| 1. Liquid Cristal Display (LCD) | 4. pH electrode DIN connector |
| 2. Keypad | 5. Conductivity (EC) probe cable |
| 3. Power adapter cable | 6. Mounting holes |

Keypad Description

- | | |
|---|--|
|  | Press to enter/exit setup menu. |
|  | Press to enter/exit calibration menu. |
|  | Press to edit items. |
|   | Press to navigate menus and select items. |
|  | Press to exit setup/calibration or cancel value edit (revert to previous value). |

LCD Description

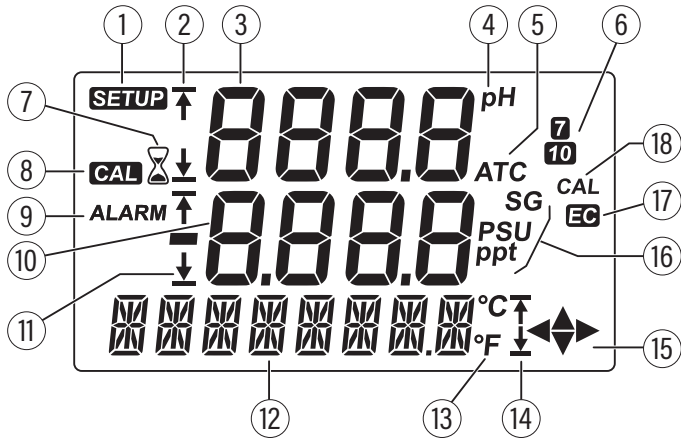

- | | |
|--|---|
| <ol style="list-style-type: none"> 1. Setup menu tag (SETUP) 2. pH Alarm indicators, High (↕) or Low (↕) 3. First LCD line, pH reading 4. First LCD line measurement unit (pH) 5. Automatic temperature compensation tag (ATC) 6. pH calibration buffer tags (7 10) 7. Stability indicator (⏰) 8. Calibration menu tag (CAL) 9. Alarm tag (ALARM) 10. Second LCD line, conductivity reading | <ol style="list-style-type: none"> 11. EC Alarm indicators, High (↕) or Low (↕) 12. Third LCD line, message area / temp. reading 13. Third LCD line, temperature unit (°C or °F) 14. Temp. Alarm indicators, High (↕) or Low (↕) 15. Navigation arrows (↔) available in setup or calibration menu 16. Second LCD line, conductivity measurement unit (ppt, PSU, SG) 17. EC tag (EC) 18. Calibrated tag (CAL) |
|--|---|

5. INSTALLATION

Monitor Mount

Supplied pre-cut strips feature a strong adhesive that adheres to most smooth surfaces e.g. glass, metal, tile.

- the rough side should be affixed to the (tank) wall
- the smooth side affixed to the monitor



1. Clean the surface the strip is affixed to.
2. Peel off the protective backing and firmly press against the surface.
3. Allow adhesive bond to set for 24 hours before mounting the instrument.

Note: Do not reuse the strips.

Attach the Suction Cup & Secure the Probe

1. Clean and dry the surface the cup is affixed to.
2. Wipe clean (soapy water) the inside of the cup and pat dry.
3. Stick the cup on the aquarium (tank) wall.
4. Firmly press the suction cup down in the middle.
(with use, regularly press the cup down to get rid of any air pockets)
5. Allow the seal to set before clicking in the probe.
6. Using the cup, secure the probe to the back of the aquarium (tank) so that the temperature sensor (EC) and junction (pH) part of the probe is submerged.

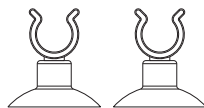

Note: Regularly check the suction cup grip.

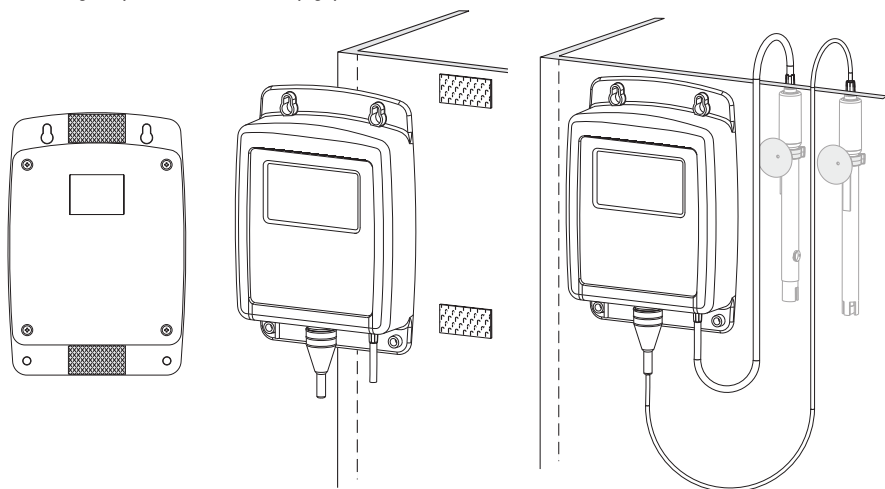

Alternative Screw Mount Option (user supplied)

1. Prepare the correct screws and screwdriver.
2. Use the keyholes at the top and bottom of the monitor panel as a reference to mark the position of the screw holes on the wall.
3. Drill the screw holes.
4. Install screw anchors if attaching to masonry.
5. Align the panel keyholes over the drilled holes.
6. Secure controller in place by installing screws in the holes.

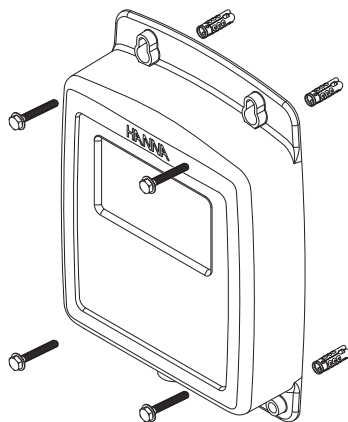

6. SETUP

- Press **SETUP** key to enter/exit setup menu.
- Press **▲** / **▼** key to navigate the menu and select items
- Press **▶** key to edit items. Press **▲** / **▼** key to edit values (blinking).
- Press **▶** key after editing to save the value or **◀** key to exit edit mode without saving.
- Press **SETUP** key to exit setup and save changes.

General Settings (Options / Default)

Temperature Unit

°C or °F
(°C)

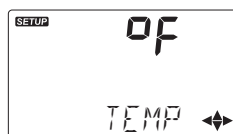

Salinity Unit

Ppt, PSu, SG
(Ppt)

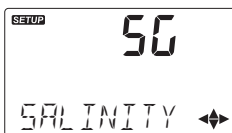
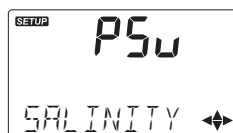
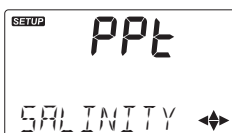

Backlight

On or Off
(On)

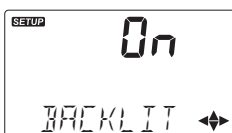

Key Beeper

On or Off
(On)



Alarm Sound

On or Off
(On)

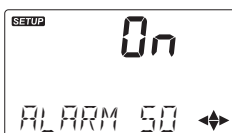

"ALARM SOUND" is scrolled on the bottom of the LCD.

pH Alarm (Options / Default)

pH High Alarm

Enabled (En), Disabled (dIS)
(Enabled)

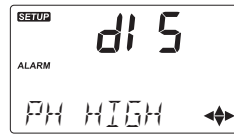
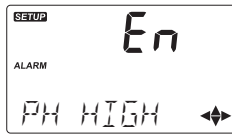

pH High Value

0.1 to 14.0 pH *
(8.6 pH)

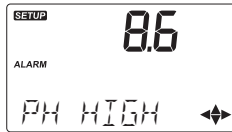

With pH High Alarm configured as enabled "PH HIGH VALUE" is scrolled on the bottom of the LCD. Actual pH value (editable) is displayed blinking.

Press to enter edit mode and use / to change value. Press to save.

pH Low Alarm

Enabled (En), Disabled (dIS)
(Enabled)

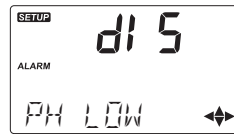

pH Low Value

0.0 to 13.9 pH *
(7.7 pH)

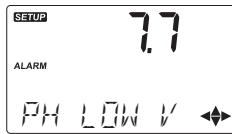

With Low Alarm configured as enabled "PH LOW VALUE" is scrolled on the bottom of the LCD. Actual pH value (editable) is displayed blinking.

Press to enter edit mode and use / to change value. Press to save.

* Available range changes based upon other settings. High alarm value must be set higher than low alarm (e.g. if low alarm was set 7 pH, then high alarm range is 7.1 to 14 pH).

EC Alarm (Options / Default)

EC High Alarm

Enabled (En), Disabled (dIS)
(Enabled)

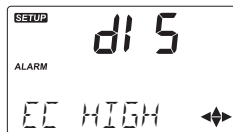
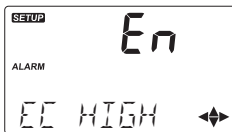

EC High Value

0.1 to 70.0 ppt * (37.0 ppt)
0.1 to 70.0 PSU * (37.0 PSU)
1.001 to 1.041 SG * (1.028 SG)

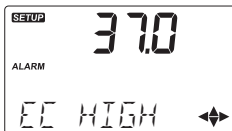

With EC High Alarm configured as enabled "EC HIGH VALUE" is scrolled on the bottom of the LCD. Actual EC value for high alarm (editable) is displayed blinking.

Press to enter edit mode and use / to change value. Press to save.

EC Low Alarm

Enabled (En), Disabled (dIS)
(Enabled)

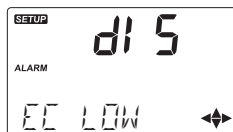
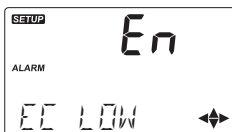

EC Low Value

0.0 to 69.9 ppt * (33.0 ppt)
0.0 to 69.9 PSU * (33.0 PSU)
1.000 to 1.040 SG * (1.025 SG)

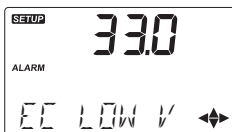

With EC Low Alarm configured as enabled "EC LOW VALUE" is scrolled on the bottom of the LCD. Actual EC value for low alarm (editable) is displayed blinking.

Press to enter edit mode and use / to change value. Press to save.

* Available range changes based upon other settings. High alarm value must be set higher than low alarm (e.g. if low alarm was set 10.0 ppt, then high alarm range is 10.1 ppt to 70 ppt).

Temperature Alarm (Options / Default)

Temperature High Alarm

Enabled (En), Disabled (dIS)
(Enabled)



"TEMP HIGH" is scrolled on the bottom of the LCD.

Temperature High Value

0.1 to 50.0 °C* (26.6 °C)
32.1 to 122.0 °F* (80.0 °F)



With Temperature High Alarm configured as enabled "TEMP HIGH VALUE" is scrolled on the LCD. Actual high alarm temperature value (editable) is displayed blinking.

Press to enter edit mode and use / to change value. Press to save.

Temperature Low Alarm

Enabled (En), Disabled (dIS)
(Enabled)



Temperature Low Value

0.0 to 49.9 °C* (23.3 °C)
32.0 to 121.9 °F* (74.0 °F)

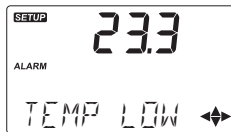





With Temperature Low Alarm configured as enabled "TEMP LOW VALUE" is scrolled on the LCD. Actual low alarm temperature value (editable) is displayed blinking.

Press to enter edit mode and use / to change value. Press to save.

7. CALIBRATION

Operation

1. Press  key to enter calibration mode.
2. Press  /  key to toggle between pH and EC modes.
3. Press  key to start calibration and  key to exit calibration.

7.1. pH

Calibrate the probe frequently for improved accuracy. Additionally, calibrate the probe:

- before installation
- whenever the probe is replaced
- after periodic maintenance

Always use fresh calibration buffers and perform electrode maintenance prior to calibration (see “Maintenance & Care” section).

Preparation

Pour the buffer solution into clean beakers. If possible, use plastic beakers to minimize any EMC interferences. For accurate calibration and to minimize cross-contamination, use two beakers, one for rinsing the probe and one for calibration.

Remove the pH electrode protective cap.

Place both electrodes in pH calibration buffers to have read values temperature compensated correctly.

Procedure

One- or two-point calibration can be performed using one of the two standard buffer solutions: 7.01 or 10.01 pH. When a two-point calibration is required, use 7.01 pH buffer as first calibration point.

One-Point Calibration

1. Press  key to enter calibration mode. Selected calibration mode is displayed blinking.



2. Press  key to start. “7.01 pH USE” is displayed as calibration point.

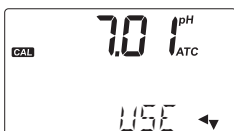

- Place the electrodes in 7.01 pH or 10.01 pH buffer solution.

Dislodge any bubbles that may adhere.

When the buffer is recognized "REC" is displayed. "WAIT" is displayed until the reading is stable and the calibration is accepted.

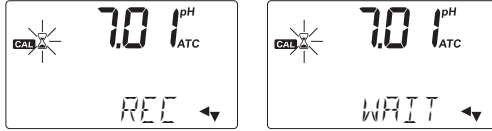

- If 7.01 pH was used, press  key to save calibration point and exit calibration mode. If 10.01 pH was used, the calibration point is automatically saved and the instrument returns to measurement mode.

Two-Point Calibration

- After 7.01 pH has been accepted, the "10.01 pH USE" message is displayed.



- Place the electrodes in second calibration buffer. When the buffer is recognized "REC" is displayed. "WAIT" is displayed until the reading is stable and the calibration is accepted.

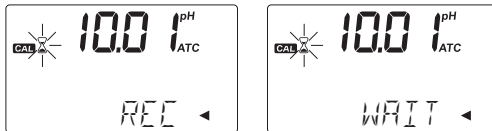

After the second calibration buffer has been accepted, the "SAVE" message is displayed and the instrument returns to measurement mode.

The "CAL" tag is displayed in measurement mode.

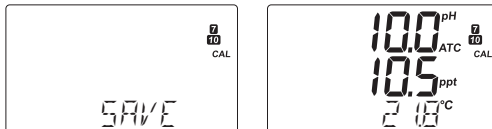

7.2. CONDUCTIVITY

Calibrate the probe frequently for improved accuracy. Additionally, calibrate the probe:

- before installation
- whenever the probe is replaced
- after periodic maintenance

Always use fresh calibration solutions and perform electrode maintenance prior to calibration (see “Maintenance & Care” section).

Preparation

Pour standard solution into clean beakers sufficient to cover the sensing portion of the probe.

If possible, use plastic beakers to minimize any EMC interferences. For accurate calibration and to minimize cross-contamination, use two beakers, one for rinsing the probe and one for calibration.

Procedure

- Raise and lower the probe in the standard to ensure the entire cell area is filled with standard.
- Shake any bubbles off the two electrodes.
- Center probe in beaker away from beaker walls.

One-point calibration

One-point calibration can be performed using 35.00 ppt salinity standard solution.

1. Press **CAL** key to enter calibration mode.
2. Press **▼** key to select EC calibration. Selected calibration mode is displayed blinking.



3. Press **▶** key to start. “35.0 ppt USE” message is displayed as calibration point.



4. Used standard is automatically recognized. When the standard is recognized “REC” is displayed. “WAIT” is displayed until the reading is stable and the calibration is accepted.



After the standard is accepted, "SAVE" is displayed and the instrument returns to measurement mode.

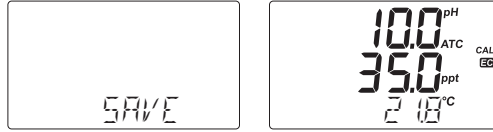

7.3. CLEAR CALIBRATION

1. Press  key to clear any saved calibration. "CLEAR" is displayed blinking.



2. Press  key to confirm. The calibration is deleted and the instrument returns to measurement mode. No "CAL" tag in measurement mode indicates that the probe is no longer calibrated.

8. MEASUREMENT

1. Connect supplied 12 Vdc power adapter to the instrument and plug the unit to the mains. All LCD segments are briefly displayed and the instrument enters measurement mode.
2. Slide the BNC connector sheath down and connect the pH electrode to the BNC socket. Slide the protective sheath back up. For maximum water protection, ensure the BNC connector is completely covered.
3. Remove the pH electrode protective cap.
4. Attached conductivity probe is automatically recognized.
5. After configuring the monitor menu, probe, and all accessories, the instrument is ready for measurement.
6. With the suction cups affixed in position, secure the probes and immerse the tips 4 cm/1½" into the monitored sample. For best accuracy, the probes should not touch.
7. Allow the readings to stabilize. "CAL" tag in measurement mode indicates that the probe has been calibrated.



9. MAINTENANCE & CARE

Cleaning, calibrating, and appropriate storage are essential for accurate readings and extend the life of the probes.

General Maintenance

- Inspect, clean, and calibrate the probe at regular intervals.
- Inspect all connectors for corrosion and replace if necessary.
- Inspect the cable. The connection cable must be intact.
- Calibrate the probe after prolonged storage or cleaning.
- After use rinse the probe with tap water and dry it.

pH conditioning

- Remove the protective cap.
- Shake down the probe to eliminate any air bubbles inside the glass bulb.
- If the bulb and/or junction are dry, soak the electrode in [HI70300](#) Storage solution for at least 30 minutes.
- To ensure a quick response time, the glass bulb and the junction should be kept moist and not allowed to dry.

pH cleaning

new probe

- Remove the protective cap.
- Rinse off salt deposits with water.

probe removed from tank

1. Rinse thoroughly with a stream of running tap water. **Weekly**, clean by soaking in [HI7061](#) Electrode cleaning solution for general use for 15 minutes or use an application-specific cleaning solution.
2. Rinse with water and soak in [HI70300](#) Storage solution for at least 30 minutes before reinstalling it.
3. Calibrate before use.

Storage

- When the probe is removed from the tank for more than 1 h, fill the protective cap with [HI70300](#) Storage solution and tighten the cap on the sensor.
- Do not store the probe in distilled or deionized water.

Conductivity probe cleaning

- To help control algae growth clean the probe with tap water **weekly**.
- If necessary a more thorough cleaning may be made using a non-abrasive detergent and a soft material to help dislodge any foreign material.
- Follow cleaning with a rinse under a stream of running tap water to remove salt or mineral coatings. Jet the tap water stream through the opening to dislodge any material. Shake excess water from the probe.
- Recalibrate before using.

Storage

- Store the probe clean.

10. WARNINGS & ERRORS

HI981520 displays warning messages when erroneous conditions appear and readings are outside supported range.

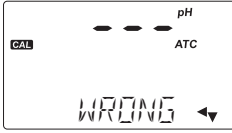

Buffer solution is not recognized.
Probe has not been placed in solution or the reading is outside accepted range.
Change the solution and/or clean the electrode.



Measured value is out of range.



Temperature sensor not reading correctly.
Contact Hanna® technical support at tech@hannainst.com

11. ACCESSORIES

Ordering Codes	Description
HI1286	Double junction pH electrode with 2 m (6.6') cable
HI70007P	pH 7.01 buffer solution, 20 mL sachet (25 pcs.)
HI7007M	pH 7.01 buffer solution, 230 mL bottle
HI70010P	pH 10.01 buffer solution, 20 mL sachet (25 pcs.)
HI7010M	pH 10.01 buffer solution, 230 mL bottle
HI70024M	35.00 ppt salinity calibration solution, 230 mL bottle
HI70024P	35.00 ppt salinity calibration solution, 20 mL sachet (25 pcs.)
HI70300M	Storage solution, 230 mL bottle
HI700601P	General purpose cleaning solution, 20 mL sachet (25 pcs.)
HI7061M	General purpose cleaning solution, 230 mL bottle
HI710005	115 Vac / 12 Vdc power adapter
HI710006	230 Vac / 12 Vdc power adapter

CERTIFICATION

All Hanna[®] instruments conform to the CE European Directives and UK standards.



Disposal of Electrical & Electronic Equipment

The product should not be treated as household waste. Instead, hand it over to the appropriate collection point for the recycling of electrical and electronic equipment, which will conserve natural resources.

Ensuring proper product disposal prevents potential negative consequences for the environment and human health.



For more information, contact your city, your local household waste disposal service, or the place of purchase.

RECOMMENDATIONS FOR USERS

Before using this instrument, make sure that it is entirely suitable for your specific application and for the environment in which it is used. Any variation introduced by the user to the supplied equipment may degrade the instrument's performance. For your and the instrument's safety do not use or store the instrument in hazardous environments.

WARRANTY

HI981520 is warranted for a period of two years against defects in workmanship and materials when used for its intended purpose and maintained according to instructions. pH probe is warranted for a period of six months. This warranty is limited to repair or replacement free of charge. Damage due to accidents, misuse, tampering, or lack of prescribed maintenance is not covered. If service is required, contact your local Hanna Instruments[®] office.

If under warranty, report the model number, date of purchase, serial number and the nature of the problem. If the repair is not covered by the warranty, you will be notified of the charges incurred. If the instrument is to be returned to Hanna Instruments office, first obtain a Returned Goods Authorization (RGA) number from the Technical Service department and then send it with shipping costs prepaid. When shipping any instrument, make sure it is properly packaged for complete protection.