

HI520

Dual-Channel Universal Process Controller

Multiparameter Platform



Dear Customer,

Thank you for choosing a Hanna Instruments® product.

Please read this instruction manual carefully before using this instrument as it provides the necessary information for correct use of this instrument, as well as a precise idea of its versatility.

This manual has been written for **HIS20** Dual-Channel Process Controller with software version v1.00 and higher. It contains information that applies to setup, installation, and operation of **HIS20-0320** or **HIS20-0540** controller paired with probes from following configurable series:

Configurable probe* series	Parameter
HI10x6-y8zz	pH
HI1026-1803	pH Meat
HI1126-1805	pH General Food Applications
HI20x4-y8zz	ORP
HI7630-y8zz	Conductivity
HI7640-18zz	Galvanic Dissolved Oxygen
HI7640-58zz	Optical Dissolved Oxygen

* Sold separately. Refer to probe manuals for specifications, installation, and application fields. x, y, zz configurable options. See **2.2 Supported Probe Series Configurations** for details.

If you need additional technical information, do not hesitate to e-mail us at tech@hannainst.com. Visit www.hannainst.com for more information about Hanna Instruments and our products.

All rights are reserved. Reproduction in whole or in part is prohibited without the written consent of the copyright owner, Hanna Instruments Inc., Woonsocket, Rhode Island, 02895, USA. Hanna Instruments reserves the right to modify the design, construction, or appearance of its products without advance notice.

TABLE OF CONTENTS

1. Introduction	4	19.5. Cleaning Triggers	104
1.1. Preliminary Examination	4	19.6. Stop Cleaning	105
1.2. Safety Measures	4	20. HI520 Events Management System	107
1.3. General Description & Intended Use	5	21. Measuring with pH & ORP Probes	114
2. Specifications	8	21.1. General Installation Considerations	114
2.1. Controller	8	21.2. Installation Schemes & Mounting	114
2.2. Supported Probe Series Configurations	10	21.3. Configurable Measurement Parameters	118
3. Controller Basics	11	21.4. Calibration	119
3.1. Front Panel	11	21.5. Conditioning & Maintenance	125
3.2. Contextual Help	13	22. Measuring with EC Probes	126
3.3. Icons & Functions	13	22.1. General Installation Considerations	126
3.4. USB-C Port	14	22.2. Installation Schemes & Mounting	126
3.5. Measurement Screens	15	22.3. Configurable Measurement Parameters	129
4. Installation & Controller Start-Up	17	22.4. Calibration	132
4.1. Installation Hardware	17	22.5. Maintenance	137
4.2. Wiring	24	23. Measuring with Galvanic DO Probes	138
4.3. Starting-Up the Controller	31	23.1. Probe Preparation & Conditioning	138
5. Controller Setup — Menu Structure	32	23.2. General Installation Considerations	139
6. Channel	33	23.3. Installation Schemes & Mounting	139
6.1. Probe Settings Navigation	33	23.4. Configurable Measurement Parameters	142
6.2. Probe Settings, General Parameters	34	23.5. Calibration	144
6.3. (Process) Control & Alarm Settings	36	23.6. Maintenance	147
7. Hold Mode	46	24. Measuring with Optical DO Probes	148
7.1. Turning On Manual Hold	46	24.1. Probe Preparation & Conditioning	148
7.2. Configuring External Hold Trigger	46	24.2. General Installation Considerations	149
8. Math Channel	48	24.3. Installation Schemes & Mounting	149
8.1. Math Channel Setup	48	24.4. Configurable Measurement Parameters	151
8.2. Math Channel Measurement	49	24.5. Calibration	153
9. Sequential Control	49	25. Modbus Remote Control	158
10. Outputs	49	25.1. Modbus Wiring	158
10.1. Relays	50	25.2. Operating Modes When Using Modbus	158
10.2. Analog Outputs	51	25.3. Setup	159
11. Inputs	54	26. Troubleshooting Guide	160
12. Cleaning	56	27. Application Configuration	161
12.1. Advanced Cleaning	59	28. Accessories	162
12.2. Simple Cleaning	60	28.1. pH Calibration Solutions	162
13. Technical Menu	60	28.2. ORP Solutions	162
13.1. Pressure Calibration	61	28.3. Conductivity Solutions	162
13.2. Analog Output Calibration	62	28.4. DO Solutions & Accessories	162
13.3. Firmware Update	62	28.5. Electrode Storage Solutions	162
14. Manual Mode	63	28.6. Electrode Cleaning Solutions	163
15. Log Recall	64	28.7. Patch Cables	163
15.1. Measurement Log Files	64	28.8. Electrode Holders	163
15.2. Event Log & Event Log Types	66	28.9. Flow Cell Saddle and Fittings	165
16. General Settings	73	28.10. Mounting Kit Accessories	166
17. Functioning Modes & Process Variables	82	29. Annex	169
18. Control Modes & Algorithms	84	29.1. Buffer Values at Various Temperatures	169
19. Cleaning Mode	101	29.2. Glossary	170
19.1. Overview of Cleaning Types	101	29.3. List of Figures	171
19.2. Cleaning Block Inputs & Outputs	102	Certification	173
19.3. Cleaning Sequences	102	Recommendations for Users	173
19.4. Cleaning Algorithms	103	Warranty	173

1. INTRODUCTION

1.1. PRELIMINARY EXAMINATION

Remove the instrument and accessories from the packaging and examine it carefully.

For further assistance, please contact your local Hanna Instruments office or email us at tech@hannainst.com.

Each unit is supplied with:

- Power cable, 3 m (9.84') long
- Set of cable gland seals
- Instrument quality certificate
- Quick reference guide with QR code for user manual download

Mounting kits for supported installations are sold separately.

Note: *Save all packing material until you are sure that the instrument works correctly. Any damaged or defective item must be returned in its original packing material with the supplied accessories.*

1.2. SAFETY MEASURES

General Safety Precautions & Preliminary Installation Recommendations

Procedures and instructions detailed in this section may require special precautions to ensure the safety of the personnel performing the operations.



- Electrical connection, installation, start-up, operation and maintenance must be carried out by specialized personnel only.
- The specialized personnel must have read and understood the instructions in this manual and should adhere to them.
- User serviceable connections are all accessible inside the enclosure.
- Do not operate or energize the instrument with the case open.



- Before powering the controller, verify wiring has been done properly.
- Always disconnect the instrument from power when making electrical connections.
- Do not run other cables through the same cable gland with the power cable.
- A clearly marked disconnect switch must be installed in the vicinity of the instrument to ensure that the electrical circuit is completely de-energized for service or maintenance.
- Do not operate damaged instruments which could pose a danger.
- Damaged instruments should be clearly marked as faulty and replaced.
- If faults cannot be repaired, the instrument must be taken out of service and secured against unintentional start-up.

Built-in Safety Features

- All electrical connections enclosed in an IP65 rated enclosure
- Galvanic isolation for all inputs and outputs
- EMC (electromagnetic compliant) hardware and software design

Notes:

- *If system faults or a power failure occurs, a fault-signaling contact triggers the alarm.*
- *The H1520 controller has been tested for EMC in industrial use according to radiated emissions.*
- *Wiring or wiring changes (i.e. Probe, Relays, RS-485 communication port, Inputs, Outputs) must be carried out after the controller has been turned off from power.*

1.3. GENERAL DESCRIPTION & INTENDED USE

HI520 is a dual-input process controller that accepts virtually any combination of compatible probes.

Designed to adapt to unique process control requirements, HI520 operates a control-loop system whereby users have the option to run channel control independently or configure to be triggered sequentially upon reaching the other channel's set point(s) (1, 2, or both).

The device operates a logical channel with built-in mathematical functions. This function is intended for when the controller works as an analyzer for monitoring high/low parameter levels between two identical input types with identical measurement configurations.

Standardized main unit and mounting accessories (compatible with a variety of installations), plug and play operation with all supported probes, secure and waterproof connections between controller and probe make HI520 unit a versatile multiparameter platform.

The controller can be configured for a wide range of applications requiring control and monitoring of four main water-analysis parameters: pH, ORP, Conductivity, and Dissolved Oxygen and is suitable for wall-, pipe-, and panel-mounting installations.

The unit has a low profile vulcanized rubber keypad for all operations, blue LEDs to indicate when relays are energized, multi-color LEDs for detailed inspection of status.

The RS-485 interface to probe, remote control and monitoring ports are EMI protected. Safety features include fuse-protected relays and a hold-to-safe-values mode.

An intuitive interface for control setup, relay activation, alarm signaling (hold status) and the help and diagnostic feature, guide users to identify problems and suggest possible action(s) to be taken.

Configuring control parameters can be done locally or remotely using the Modbus protocol and a compatible Modbus server.

Shared-function management

Smart technology enables optimization of probes for specific applications, such as different temperatures, measurement modes, or ranges. When paired up, the system allows for shared management of settings between controller and probes, where the controller manages only settings related to the intended application, as defined by the requirements of the industrial process, and the probes manage measurement settings and warnings, including temperature compensation and calibration.

Main Features

Process input	<ul style="list-style-type: none"> • Smart probes with RS-485 connection. Automatic probe recognition and upload of configuration calibration, and measurement data.
User interface	<ul style="list-style-type: none"> • Easily navigable main menu and submenus
Analog Outputs (programmable)	<ul style="list-style-type: none"> • Two or four, depending on the controller model <ul style="list-style-type: none"> ▶ 0 – 20 mA ▶ 4 – 20 mA
Alarm Relay	<ul style="list-style-type: none"> • Activates on errors and programmable alarm conditions
Control relays (programmable)	<ul style="list-style-type: none"> • Three (two SPDT + one SPST) or five (two SPDT + three SPST) contact outputs, depending on the controller model <ul style="list-style-type: none"> ▶ 5 A – 250 Vac ▶ 5 A – 30 Vdc
Cleaning function	<ul style="list-style-type: none"> • Integral water or chemical cleaner control • Configurable simple or advanced cleaning: <ul style="list-style-type: none"> ▶ triggered manually ▶ triggered at a set time interval ▶ scheduled for a specific day of the week ▶ triggered by a digital input • Blowers, water jets, washers (user supplied)
LCD display	<ul style="list-style-type: none"> • Backlit dot matrix • With virtual key function
Enclosure	<ul style="list-style-type: none"> • Rugged molded housing with hinged front panel

Additional Features

Hold mode	<ul style="list-style-type: none"> • Automatic mode for entering calibration, Setup, and cleaning cycle • Manually triggered or triggered via an external digital input
 key	<ul style="list-style-type: none"> • User help key, opens a guide for diagnosing a problem or troubleshooting
Security access code	<ul style="list-style-type: none"> • Protected calibration and setup settings
Languages	<ul style="list-style-type: none"> • English (default), Deutsch, Español, Français, Italiano, Magyar, Nederlands, Português
Remote control	<ul style="list-style-type: none"> • Monitor and control of process parameters through RS-485 (Modbus RTU)
USB-C port	<ul style="list-style-type: none"> • USB for exporting (or importing) data with a flash drive and for software update • Used to exercise relays and analog outputs • Useful for: <ul style="list-style-type: none"> ▶ setting up the system ▶ priming a pump ▶ checking wiring ▶ during general maintenance
Manual mode	<ul style="list-style-type: none"> • Default option when the industrial application requires manual input • As a safety feature, a 60-minutes timeout to exit manual mode is implemented (relays and analog outputs return to their previous value)

Data & Event logger	<ul style="list-style-type: none"> • The controller automatically logs the process control information in an interval log, and various event alarms and errors in an event log • Logged data can be retrieved and events visualized on the screen, in Log Recall menu • Interval logs store up to 8600 records per lot, maximum lot number is 100 lots • Logging interval can be set in the General settings menu • Logged data includes: <ul style="list-style-type: none"> ▶ measurement variables and temperature measurements ▶ last calibration data ▶ setup configuration ▶ start/end date and time ▶ previous values ▶ event data and event code • Event log can store up to 100 records of events, alarms, errors-related data • Log files can be uploaded to a USB flash drive via USB-C port
Calibration	<ul style="list-style-type: none"> • pH Up to three-points standard calibration with selection from two buffer groups: <ul style="list-style-type: none"> ▶ Hanna Instruments: 1.68, 4.01, 7.01, 10.01, 12.45 pH ▶ NIST: 1.68, 4.01, 6.86, 9.18, 12.45 pH • Conductivity Up to two-points user calibration with selectable calibration points: <ul style="list-style-type: none"> ▶ 0.000 $\mu\text{S}/\text{cm}$ for offset ▶ 84.0 $\mu\text{S}/\text{cm}$, 1413 $\mu\text{S}/\text{cm}$, 5.00 mS/cm, 12.88 mS/cm for 0.1/cm cell ▶ 80.0 mS/cm, 111.8 mS/cm additional standards for 1.0/cm cell • DO (Dissolved Oxygen) Up to two-points standard calibration • Single point process calibration for all supported parameters • Last calibration data stored on the probe and can be visualized in the Cal Data window • Calibration reminder can be scheduled (1 to 99 days) or set as Off
Safety	<ul style="list-style-type: none"> • When in Setup or Calibration mode, without making any changes or pressing any key, the controller will return to Measure mode and restart control.

2. SPECIFICATIONS

2.1. CONTROLLER

Model	Relays	Analog Outputs
HI520-0320	3	2
HI520-0540	5	4

2.1.1. Specifications

Supported digital probes

- **pH**
 - ▶ HI1006-18 (LT, PTFE junction)
 - ▶ HI1016-18 (LT, ceramic junction)
 - ▶ HI1006-38 (HT, PTFE junction)
 - ▶ HI1016-38 (HT, ceramic junction)
 - ▶ HI1006-48 (HF, PTFE junction)
 - ▶ HI1016-48 (HF, ceramic junction)
 - ▶ HI1026-1803 (meat applications only)
 - ▶ HI1126-1805 (general food applications)
- **ORP**
 - ▶ HI2004-18 (platinum sensor, PTFE junction)
 - ▶ HI2014-18 (platinum sensor, ceramic junction)
 - ▶ HI2004-28 (gold sensor, PTFE junction)
 - ▶ HI2014-28 (gold sensor, ceramic junction)
- **conductivity**
 - ▶ HI7630-28 (two-electrode cell)
 - ▶ HI7630-48 (four-ring, platinum on glass)
- **galvanic Dissolved Oxygen**
 - ▶ HI7640-18
- **optical Dissolved Oxygen**
 - ▶ HI7640-58

Display	Graphic LCD, 128 × 64 pixel B/W with backlight
Digital inputs	2 independent, galvanically isolated inputs, configurable for Hold & Cleaning functions On state: 5 to 24 Vdc, low or high level active

Analog outputs	2 or 4 independent outputs 0 – 22 mA configurable as: ▶ 0 – 20 mA ▶ 4 – 20 mA ▶ 22 mA as alarm signal
Analog output accuracy	±0.2 % f.s.
Digital communication	<ul style="list-style-type: none"> • RS-485 serial port for remote monitoring and control (Modbus) • USB-C port to retrieve log files and firmware upgrading
Relays	Up to 5 relays, independently configurable for process variables, Hold and Cleaning functions Electromechanical relay outputs 5 A – 250 Vac; 5 A – 30 Vdc (resistive load) Fuse protected: 5 A, 250 V slow blow fuse
Alarm relay for all measurement alarms	Electromechanical relay SPDT contact output 5 A – 250 Vac; 5 A – 30 Vdc (resistive load) Fuse protected: 5 A, 250 V slow blow fuse
Data logging	<ul style="list-style-type: none"> • Interval log, up to 100 files, maximum 8600 records on each stored file. When the maximum limit is reached, the most recent file will automatically erase the oldest one. • Event log, maximum 100 records. When the maximum limit is reached, the last record overwrites the oldest one.
Power supply	100 – 240 Vac ± 10 %; 50/60 Hz; 15 VA; fuse protected (2 A, 250 V slow blow fuse)
Power consumption	15 VA
Installation category	II
Enclosure*	Single case ½ DIN, IP65 ingress protection
Weight	Approximately 1.6 kg (3.5 lb.)
Dimensions	Width 144.0 mm (5.7") Height 144.0 mm (5.7") Depth 151.3 mm (6.0")
Environment	–20 to 50 °C (–4 to 122 °F); maximum 100 % RH non-condensing

* For a water tight seal, tighten the four front casing screws to 13.3 lbf•in (1.5 N•m, max. 2.0 N•m), of torque.

2.2. SUPPORTED PROBE SERIES CONFIGURATIONS

HI10 [x] [x] - [y] [8] [z] [z] pH

xx	06	PolyTetraFluoro-Ethylene (PTFE) junction	
	16	Ceramic junction	
	1	Low Temperature (LT) glass sensor, titanium matching pin -5.0 to 80.0 °C (23.0 to 176.0 °F)	0.00 to 12.00 pH
y	3	High Temperature (HT) glass sensor, titanium matching pin 0.0 to 100.0 °C (32.0 to 212.0 °F)	0.00 to 14.00 pH
	4	Fluoride-resistant (HF) glass sensor, titanium matching pin -5.0 to 60.0 °C (23.0 to 140.0 °F)	0.00 to 10.00 pH

HI20 [x] [x] - [y] [8] [z] [z] Oxidation-Reduction Potential (ORP)

xx	04	PolytetraFluoro-Ethylene (PTFE) junction	
	14	Ceramic junction	
	1	Platinum sensor -5.0 to 100.0 °C (23.0 to 212.0 °F)	±2000 mV
y	2	Gold sensor -5.0 to 100.0 °C (23.0 to 212.0 °F)	±2000 mV

HI7630 - [y] [8] [z] [z] Conductivity (EC)

	2	Two-electrode cell conductivity, AISI 316 stainless steel, cell constant k ≈ 0.1/cm 0.0 to 50.0 °C (32.0 to 122.0 °F)	EC 0.000 μS/cm to 30.00 mS/cm TDS 0.000 mg/L to 15.00 g/L (TDS factor 0.5) RES 34 Ω • cm to 99.99 MΩ • cm
y	4	Four-ring conductivity, platinum on glass, cell constant k ≈ 1.0/cm 0.0 to 100.0 °C (32.0 to 212.0 °F)	EC 0.0 μS/cm to 999.9 mS/cm TDS 0.0 mg/L to 400.0 g/L (TDS factor 0.5) RES 1.00 Ω • cm to 9.99 MΩ • cm Seawater Salinity 400.0 %NaCl, 42 psu, 80 ppt

HI7640 - [1] [8] [z] [z] Galvanic Dissolved Oxygen

	1	Galvanic sensor -5.0 to 50.0 °C (23.0 to 122.0 °F)	Concentration 0.00 to 50.00 mg/L (ppm) Saturation 0.0 to 500.0 %
--	---	---	---

HI7640 - [5] [8] [z] [z] Optical Dissolved Oxygen

	5	Optical sensor -5.0 to 50.0 °C (23.0 to 122.0 °F)	Concentration 0.00 to 50.00 mg/L (ppm) Saturation 0.0 to 500.0 %
--	---	--	---

	8	Smart probe, with RS-485 connection
zz	00	supplied with DIN connector (without cable). See 28 Accessories section for cable ordering codes.
	05, 10, 15, 25, 50	cable length (meters)

3. CONTROLLER BASICS

3.1. FRONT PANEL

- The front panel includes a graphic display and keypad with tactile feedback
- Two LEDs, ALARM and STATUS, indicate alarm and status conditions
- HOLD LED lights up yellow indicating controller HOLD status
- Depending on the model, up to five additional LEDs light up blue, indicating relay status

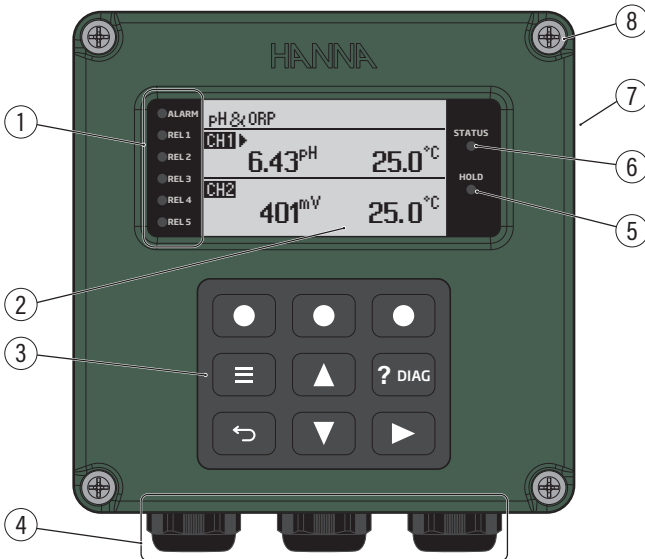

Figure 1: Front Panel & Keypad Description

Front Panel & Keypad

1	Alarm & Control relay LEDs
2	Graphic Display (LCD)
3	Keypad
4	Cable glands
5	Hold LED
6	Status LED
7	USB-C Port
8	Captive spring loaded screws

3.1.1. LCD Display Functions

Screenshots below show typical examples of measurement screen areas for readings taken with two wired probes. CH1 displays pH measurement data and CH2 displays conductivity (EC) measurement data.

Notes:

- Units for measured value change, depending on wired probe.
- For conductivity measurements, the controller displays the temperature compensation mode status.

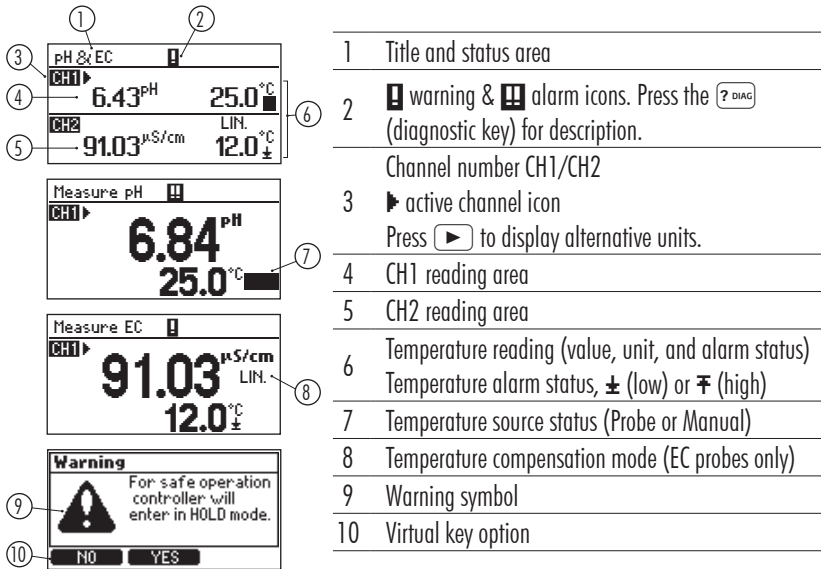

Figure 2: Display Description

3.1.2. Keypad

There are six functional keys and three virtual keys that change function with the display above.

Functional Keys

- direct Menu key
Permits access to calibration and Setup parameters.
- direct diagnostic/help key
Opens a guide for Setup or diagnosing a problem or troubleshooting.
- back functional key
Returns the user to previous hierarchical menu level.
Performs an exit or escape function.
- directional arrow keys
Move the user through the menu and submenu in either direction.
May be used to increment one position.
May be used to move continuously through a menu or string of values by holding the key in the depressed position.





Virtual Keys

- 











Perform the functions displayed on the bottom of the display screen.
Used to set or modify parameters values or to access, export, or delete log files.

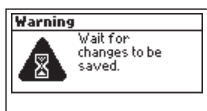
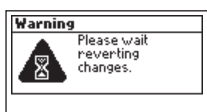

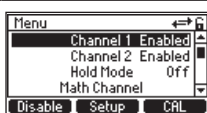
3.2. CONTEXTUAL HELP

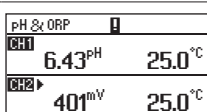
HI520 offers an interactive contextual help mode that assists the user at any time.

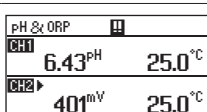
- Press  (diagnostic key) to access the help screen.
The instrument will display additional information related to the current screen.
- Use the   keys to scroll the text to read all the available information.
- Press  (back key) to exit help mode. The controller returns to the previous screen.

3.3. ICONS & FUNCTIONS

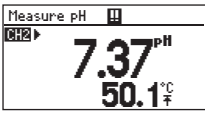
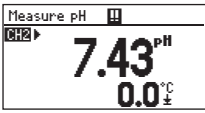
Symbol	Example	Function
		A warning symbol that requires user consent.
	 	A warning symbol asking the user to be patient as information is saved (or reverted) inside the probe and updated.
 		Displayed in the top right corner of the title & status area, indicates instrument password protection status.
		Displayed in the middle of the title and status area, indicates a warning. Press  (diagnostic key) for a description and suggested action.
		Displayed in the title and status area, indicates an active alarm or error state. Press  (diagnostic key) for a description and suggested action.

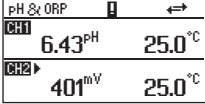
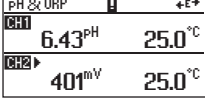
Symbol	Example	Function
⎓		Displayed next to the reading (e.g. temperature reading), indicates Alarm High on the parameter.
±		Displayed next to the reading (e.g. temperature reading), indicates Alarm Low on the parameter.
⊗		Fatal error screen. Press  and follow the displayed instructions.
↔		The controller is connected remotely via RS-485 to a Modbus server.
+E↔		The controller is connected remotely via RS-485 to a Modbus server and is in Remote Edit Mode.

3.4. USB-C PORT

The USB-C port is located on the right side of the controller.

Users can connect a USB flash-drive (directly or through an adapter) or a cable to this port.

Note: The flash drive should not be pulled out of the USB-C port while it is still in operation.

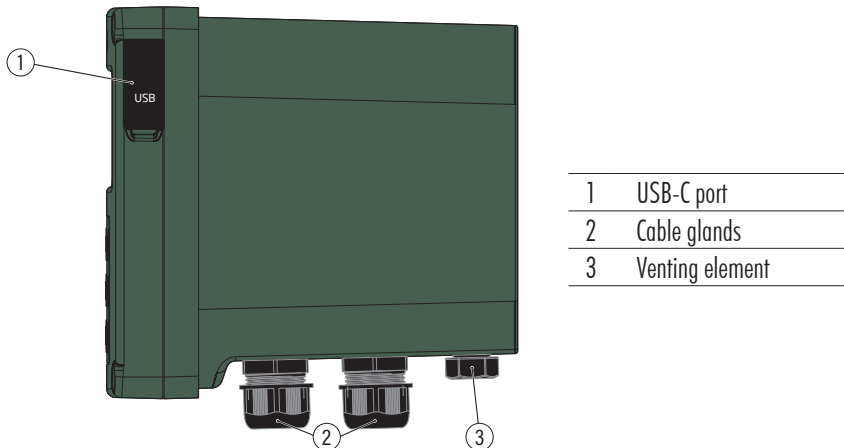

Figure 3: Side View: USB-C Port & Venting Element

3.5. MEASUREMENT SCREENS

Measure is the normal operating mode. With probe connected, controller automatically detects probe type. Screenshots below display sensor measurement data – value, unit, temperature compensation type – taken with pH, ORP, Conductivity, and Dissolved Oxygen probes.

Connected probe	Measure type	Dual & single channel display modes	
pH	pH	pH & pH CH1 6.43 ^{pH} 25.0 ^{°C} CH2 7.01 ^{pH} 19.2 ^{°C}	Measure pH CH2 ▶ 7.01^{pH} 19.2 ^{°C}
		ORP & ORP CH1 921 ^{mV} 25.0 ^{°C} CH2 401 ^{mV} 25.0 ^{°C}	Measure ORP CH2 ▶ 401^{mV} 25.0 ^{°C}
ORP	ORP	pH & EC CH1 6.43 ^{pH} 25.0 ^{°C} CH2 91.03 ^{µS/cm} LIN. 19.0 ^{°C}	Measure EC CH2 ▶ 91.03^{µS/cm} LIN. 19.0 ^{°C}
		pH & TDS CH1 6.43 ^{pH} 25.0 ^{°C} CH2 45.54 ^{PPm} LIN. 19.0 ^{°C}	Measure TDS CH2 ▶ 45.54^{PPm} LIN. 19.0 ^{°C}
Conductivity	Resistivity	pH & RES CH1 6.43 ^{pH} 25.0 ^{°C} CH2 18.0 ^{MΩ-cm} STD. 25.0 ^{°C}	Measure RES CH2 ▶ 18.0^{MΩ-cm} STD. 25.0 ^{°C}
		pH & SAL CH1 6.43 ^{pH} 25.0 ^{°C} CH2 0.1 ^{Sal %} 19.0 ^{°C}	Measure SAL CH2 ▶ 0.1^{Sal %} 19.0 ^{°C}
	Sal %	pH & SAL CH1 6.43 ^{pH} 25.0 ^{°C} CH2 0.08 ^{ppt} 25.0 ^{°C}	Measure SAL CH2 ▶ 0.08^{sal ppt} 25.0 ^{°C}
		pH & SAL CH1 6.43 ^{pH} 25.0 ^{°C} CH2 0.67 ^{psu} 25.0 ^{°C}	Measure SAL CH2 ▶ 0.67^{sal psu} 25.0 ^{°C}
Dissolved Oxygen (DO)	DO_Conc	pH & DO CH1 6.43 ^{pH} 25.0 ^{°C} CH2 7.28 ^{mg/L} 25.1 ^{°C}	Measure DO CH2 ▶ 7.28^{mg/L} 25.1 ^{°C}
		pH & DO CH1 6.43 ^{pH} 25.0 ^{°C} CH2 99.7 ^{%Sat} 25.1 ^{°C}	Measure DO CH2 ▶ 99.7^{%Sat} 25.1 ^{°C}
	DO_%Sat		



3.5.1. Selecting Measure Channel

The default display mode is dual-channel view. The controller remembers last selected mode upon restart.

- Press the   keys to select channel.

The  symbol indicates active channel.

pH & EC	
CH1 	6.43 ^{pH} 25.0 ^{°C}
CH2	2.580 ^{μS/cm} 25.0 ^{°C} <small>STD.</small>

pH & EC	
CH1 	6.43 ^{pH} 41 ^{mV}
CH2 	2.580 ^{μS/cm} 25.0 ^{°C} <small>STD.</small>

- Press the  to display alternative measure units (e.g. mV for pH or EC for TDS)

pH & EC	
CH1 	6.43 ^{pH} 25.0 ^{°C}
CH2	2.580 ^{μS/cm} 25.0 ^{°C} <small>STD.</small>

- Press the  key with CH2 selected for single-channel display (CH1, CH2, or Math).

Measure EC	
CH1 	141.7 ^{μS/cm} 25.0 ^{°C} <small>STD.</small>

Measure EC	
CH2 	2.580 ^{μS/cm} 25.0 ^{°C} <small>STD.</small>

Measure EC	
	Difference: 139.1 ^{μS/cm}

- Press the  key with Math channel active (or CH2 if Math not available) to return to the dual-channel view.

4. INSTALLATION & CONTROLLER START-UP

4.1. INSTALLATION HARDWARE

4.1.1. Guidelines

- The controller is suitable for outdoor use, but installation in direct sunlight or in areas of extreme temperature is not recommended.
- Based on controller specifications, installation thermal conditions are in the -20 to 50 °C (-4 to 122 °F) range.
- The controller should be installed in an area where vibrations and electromagnetic interference are minimized.
- Unused cable conduit entries must be securely sealed with Type 4X or IP66 conduit plugs, to maintain the ingress protection rating.
- Easy access to the controller should be available at all times.
- Safety precautions must be observed at all times! See **1.2 Safety Measures** section for details.
- The versatile enclosure design supports surface or wall-, panel-, and pipe-mount installations.

4.1.2. Wall Mount (Surface Mount)

Wall-Mount Support Surface & Inside Depth Dimensions

- horizontal mount requires at least 208 mm (8.2") wall support surface
- vertical mount requires at least 108 mm (4.3") wall support surface

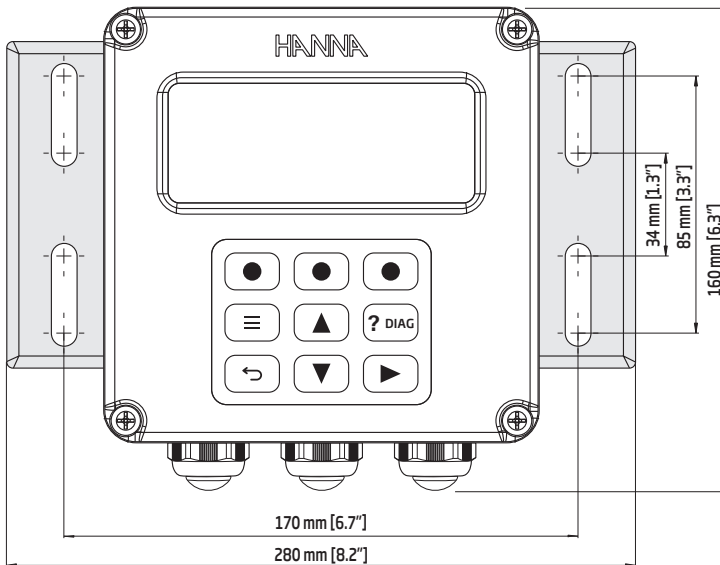

Figure 4: Wall-Mount Panel, Slots Dimensions

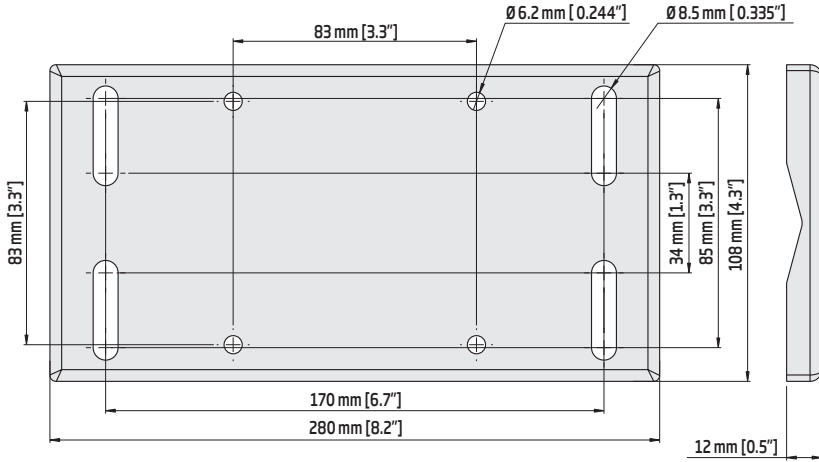

Figure 5: Wall-Mount Panel Thickness, Mounting Bolts & Slots Dimensions

The minimum depth required by a unit fastened to a 12 mm (0.5") mounting plate is 163 mm (6.4").

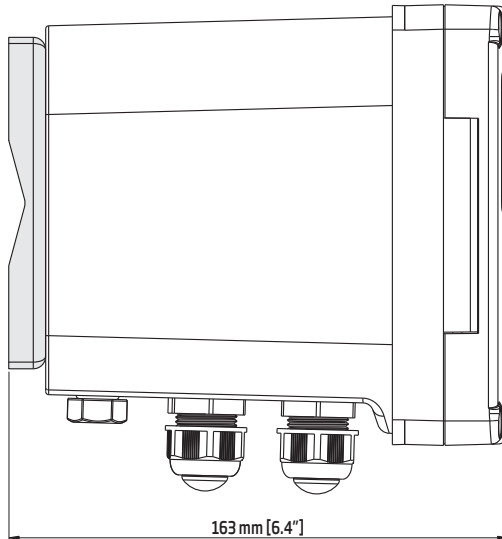

Figure 6: HI520 Controller Fastened to Wall-Mount Panel

Wall-Mount Hardware & Steps

The controller can be mounted on a wall using a Wall-Mount panel that can be fixed either horizontally or vertically. Use the Wall-Mount panel with appropriate hardware. See table, description column, for details. The mounting kit does not include the fasteners required for attaching the Wall-Mount panel to the wall. Fasteners type and length selection must be based on wall type i.e. concrete, brick, metal, wood as well as wall thickness.

Note: The four slots in the Wall-Mount plate are for user-supplied mounting fasteners between $\varnothing 6.0$ mm (1/4") and $\varnothing 8.0$ mm (5/16").

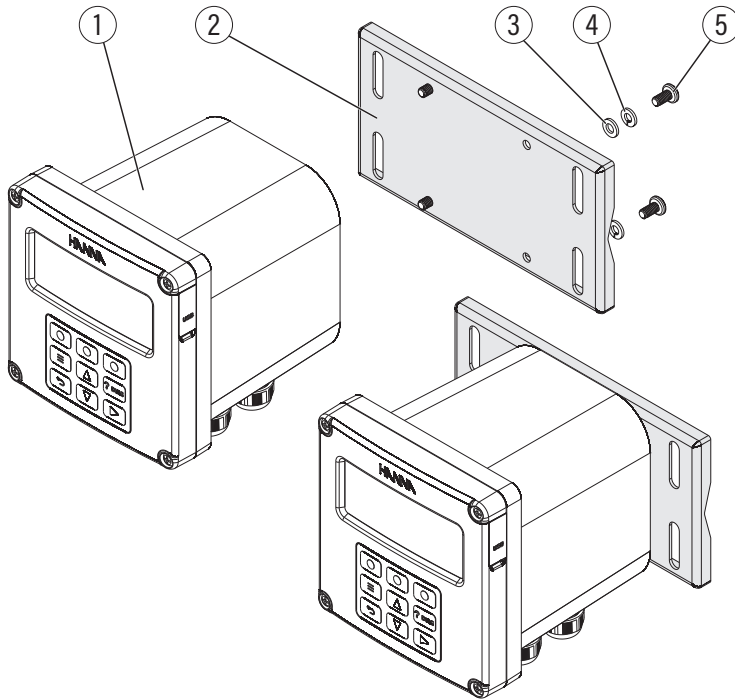

Figure 7: Wall-Mount Schematic

Wall-Mount Hardware

Label	Description	Quantity
1	Process controller	1 pc.
2	Zinc-plated, Wall-Mount panel	1 pc.
3	Plain washer for M6 screw	4 pcs.
4	Spring washer for M6 screw	4 pcs.
5	M6 × 12 mm screw (DIN 7985)	4 pcs.

To wall mount the controller:

1. Select the position desired for the controller and following the dimensions indicated in [Figure 5](#), drill the holes required for attaching the Wall-Mount panel to the surface. The drill size depends on the fasteners dimension required by wall type and thickness.
2. Fasten the Wall-Mount panel to the controller following [Figure 7](#) schematic, and using supplied screws and washers.
3. Fasten the mounting panel to the wall (surface), using four bolts.
4. For horizontal wall mount, use a leveling tool to adjust the controller in correct horizontal position.

4.1.3. Panel Mount

Inside Depth, Width & Height Dimensions

- 122 mm (4.80") minimum inside depth i.e. the dimension it extends behind the panel
- 138 mm (5.4") width x 138 mm (5.4") height
- panel thickness can go up to 10 mm (0.39"), depending on material

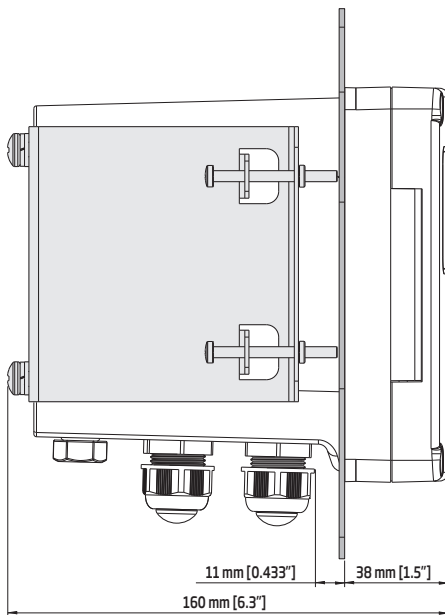

Figure 8: Panel Mount, Inside Depth

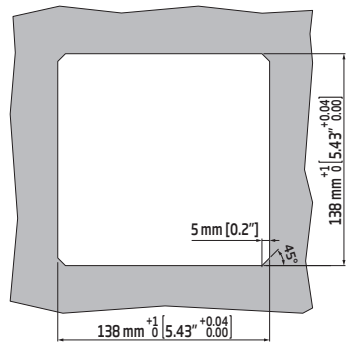

Figure 9: Panel Mount Cutout

Panel-Mount Hardware & Steps

The controller can be mounted in a panel using two brackets and appropriate, user-supplied hardware that includes external gasket and several types of screws. See table, description column, for details.

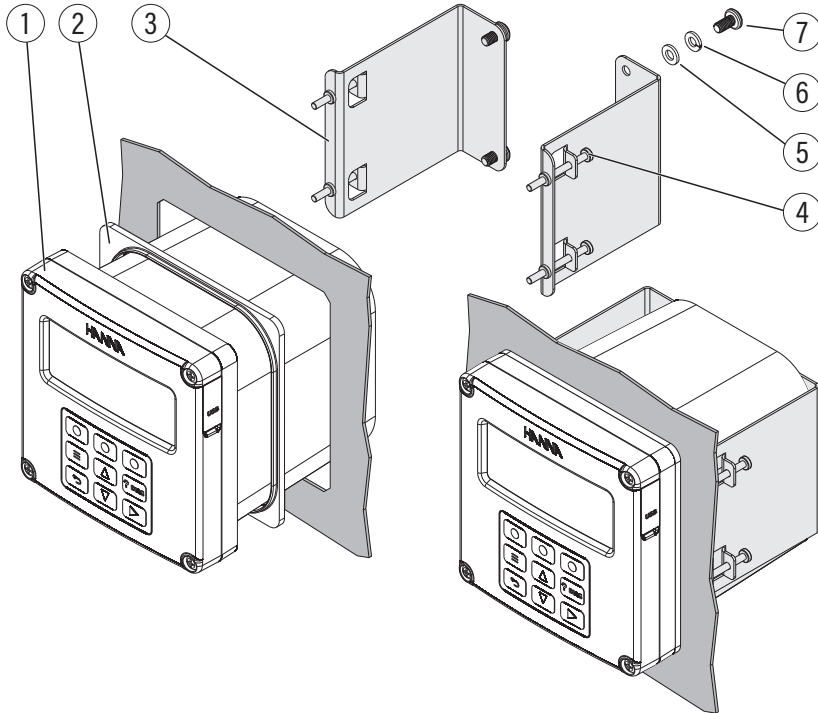

Figure 10: Panel-Mount Schematic

Panel-Mount Hardware

Label	Description	Quantity
1	Process controller	1 pc.
2	External gasket	1 pc.
3	Panel bracket, 100 mm (3.93") long	2 pcs.
4	M4 × 45 mm screw (DIN 7985)	4 pcs.
5	Plain washer for M6 screw	4 pcs.
6	Spring washer for M6 screw	4 pcs.
7	M6 × 12 mm screw (DIN 7985)	4 pcs.

To mount the controller on a panel:

1. Select the position desired for the controller on the panel, and make the cutout following dimensions indicated in [Figure 9](#). Smooth the cutout edges so as not to damage the gasket or to scratch the controller during assembly.
2. Unscrew all six M20 cable glands using an M24 socket or wrench ([Figure 11](#), part A).
3. Keep the venting element in position ([Figure 3](#), label 2).
4. Slide the gasket onto the controller and place controller into panel cutout from the front of the panel.
5. Using screws and washers, screw the brackets to the controller from back side. Screw $M6 \times 12$ mm screws into bracket and tighten against the back of the panel.
6. Screw the six cable glands ([Figure 11](#), part B) back in place.
7. Connect the protective ground wires \oplus ([Figure 11](#), part C).

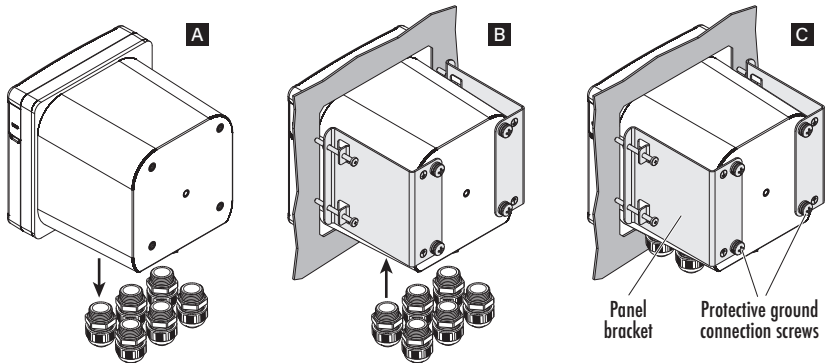

Figure 11: Panel-Mount Steps, Parts (A) (B) (C)

4.1.4. Pipe Mount

Pipe-Mount Hardware & Steps

The controller can be mounted vertically or horizontally on a pipe.

Use a mount plate and U-Bolts together with supplied hardware that includes hex nuts and several types of screws. See table, description column, for details.

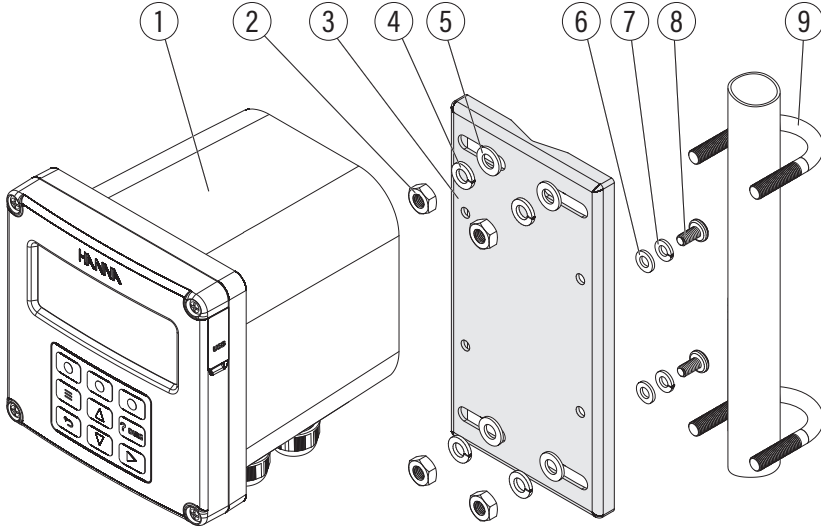

Figure 12: Pipe-Mount Schematic

Pipe-Mount Hardware

Label	Description	Quantity
1	Process controller	1 pc.
2	Hex nut M8	4 pcs.
3	Mount plate	1 pc.
4	Plain washer for M8 screw	4 pcs.
5	Spring washer M8 screw	4 pcs.
6	Plain washer for M6 screw	4 pcs.
7	Spring washer for M6 screw	4 pcs.
	U-Bolt 1"	2 pcs.
8	U-Bolt 1 ½"	2 pcs.
	U-Bolt 2 ½"	2 pcs.
9	M6 × 12 mm screw (DIN 7985)	4 pcs.

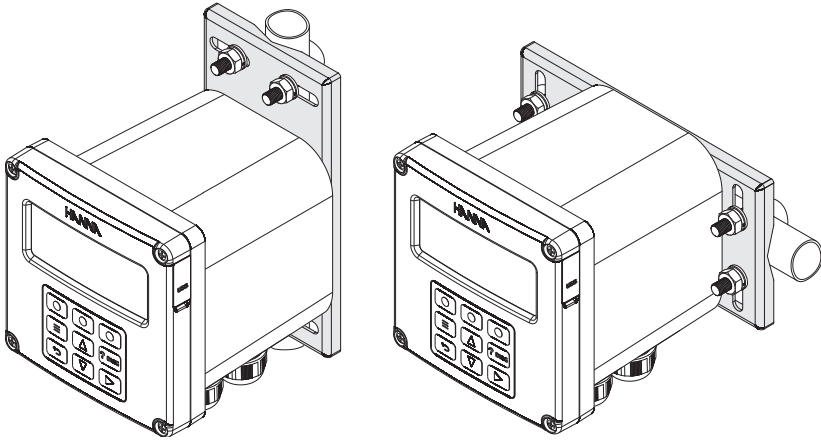

Figure 13: Vertical & Horizontal Pipe Mount

To mount the controller on a pipe:

1. Fasten mounting plate to controller, using hardware detailed in the hardware table.
2. Measure the pipe diameter and select the appropriate U-Bolt size.
The mounting kit includes three U-Bolt sizes, for pipe size from $\frac{3}{4}$ " to $2\frac{1}{2}$ ".
3. Attach the controller to the pipe and secure it using the U-Bolts, washers, and nuts.

4.2. WIRING

4.2.1. Guidelines

Accessing wiring locations:

- Loosen the four captive screws, on the front of the hinged panel, enough for the springs to push them out.
- Grasp the front bezel on the right side and swing the bezel open to the left.

A two-terminal connection system is used to wire up the controller.

- Terminal 1 connection board (Figure 19), protected by an extra cover, used for wiring relays and power source.
- Terminal 2 connection board (Figure 19), used for low-power signal connections e.g. probes, digital inputs, and analog outputs.

Both connection boards have a fixed part and plug in/push out connectors for wire connections.

Connectors and wires are protected by an IP65 enclosure.

4.2.2. Preparing Conduit Openings

- There are six conduit openings used for sealing the connection cables. Conduit openings accept 6 – 12 mm (0.237 – 0.472") cables.
- To keep the enclosure IP65 protected, block the unused openings with IP65 conduit plugs.

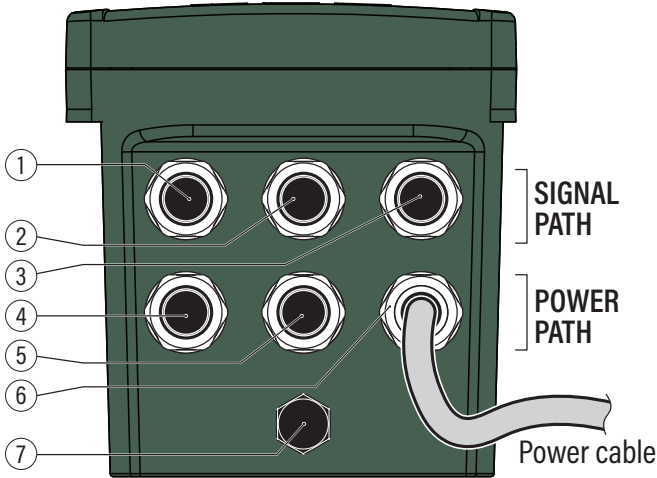
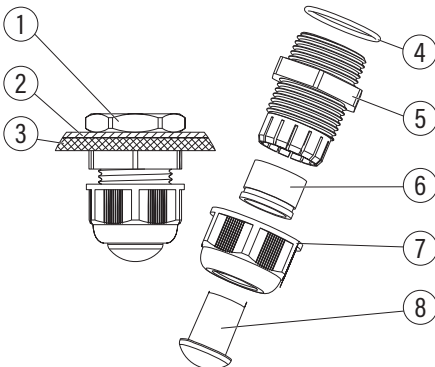

Figure 14: Conduit Openings

1	Probe 1 and remote communication
2	Analog Outputs and Digital Inputs
3	Probe 2
4	Alarm relay
5	Control relays
6	Power cable
7	Venting element

Field decision note: conduit openings 1 and 3 can accept Analog Outputs and Digital Inputs cables

Assembly drawing of an exposed cable gland below. The seal is entering from the external part and the parts are shown on each side of the enclosure wall.



1	Metallic nut
2	Metallic base plate
3	Enclosure wall
4	Cable gland seal
5	Cable gland body
6	Cable seal
7	Cable gland nut
8	Blank plug

Figure 15: Exposed Cable Gland Schematic

4.2.3. Opening the Enclosure

The front panel is hinged at the front of the enclosure for easy access to wiring locations.

To open the enclosure, loosen the four captive screws enough for the springs to push them out.

Selection of mounting location should be such that allows the front panel to swing open fully and that there is adequate room around the mounting location for wire routing.

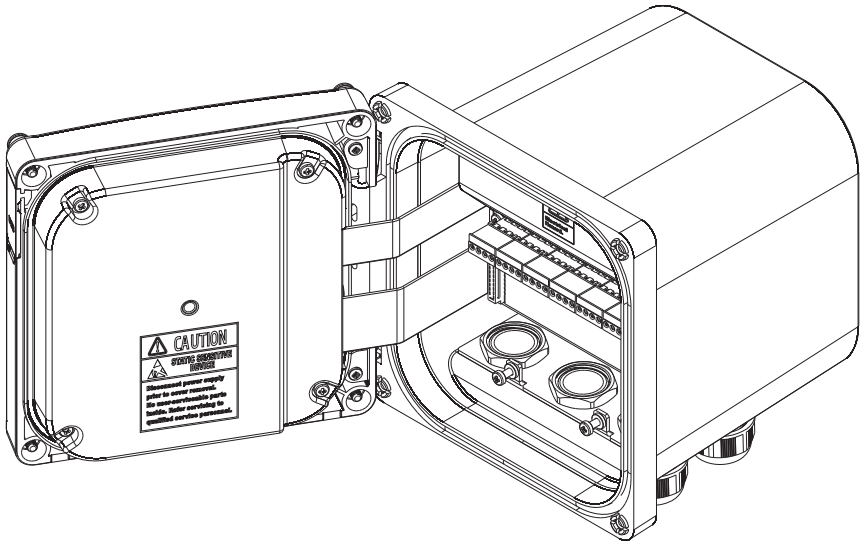

Figure 16: HI520 Enclosure Opened



Figure 17: Hinged Front Panel

4.2.4. Wiring the Controller

Easy access to **HI520** installation terminals — push in and plug out — enables quick wiring.

- **High voltage** connections (Terminal 1)
 - ▶ Power (9)
 - ▶ Alarm (1)
 - ▶ Control relays (8)
- **Low voltage** connections (Terminal 2)
 - ▶ COMM (RS-485) (2)
 - ▶ PROBE 1 (CH1) (3)
 - ▶ Digital Inputs (4)
 - ▶ Analog Outputs (6)
 - ▶ PROBE 2 (CH2) (7)

- Follow the lead markings (+ positive / – negative) to ensure that output leads are wired to the correct position on the main board.
- Run the connector cable through the designated opening and using a screwdriver connect the cable leads to the appropriate connector jack and plug them in the corresponding socket.

Note: Wiring (wiring changes) must be conducted after power supply to the controller has been turned off.

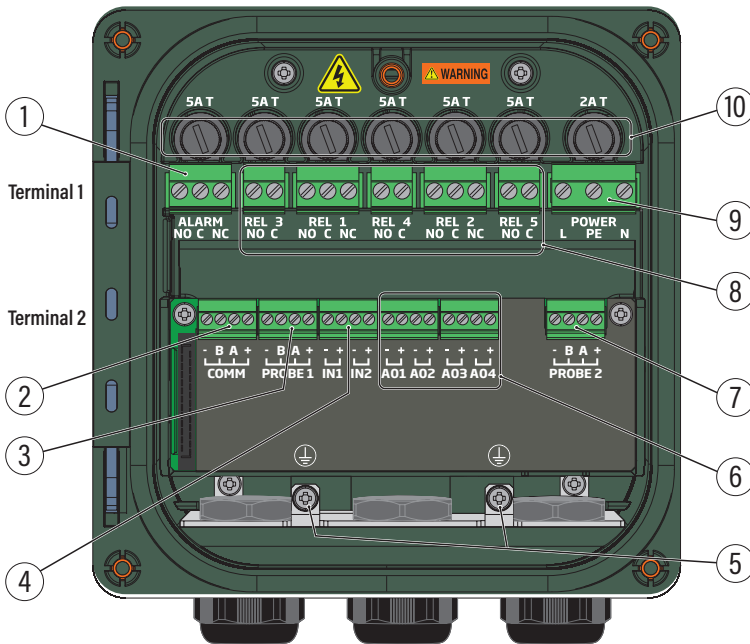

Figure 18: Signal Board & Output

1. Alarm relay connector	6. Analog Outputs connectors
2. RS-485 communication port	7. Probe 2 connector
3. Probe 1 connector	8. Relay connectors
4. Digital inputs connectors	9. Power connector
5. Protective ground connections	10. Fuses

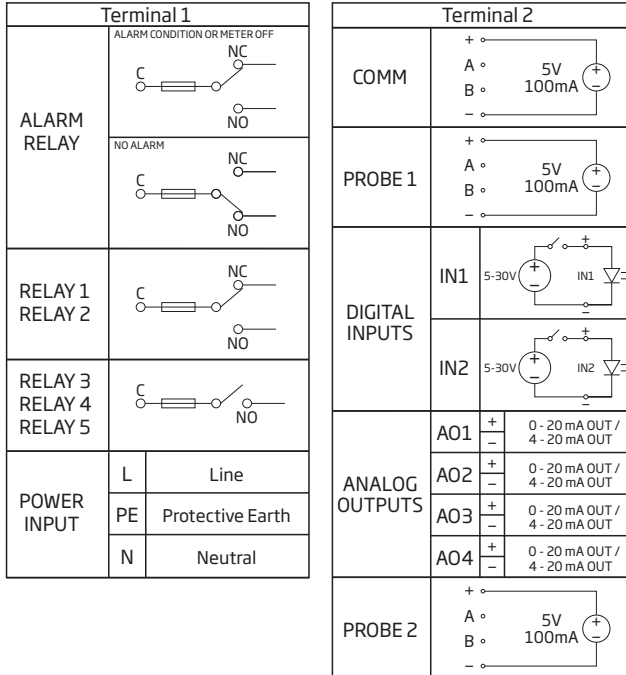

Figure 19: Input Values

4.2.4.1. Terminal 1 Wiring

Control Relay Wiring

Up to five control relays are supplied with the controller.

1. Follow the printed lead markings to ensure that the relay leads on each of the relays are wired to the correct position on the power supply board.
 - ▶ NO i.e. Normally Open
 - ▶ NC i.e. Normally Closed
 - ▶ C i.e. Common
2. Run the connection cables through conduit openings 3 and 4.
3. Use a screwdriver to connect the cable leads to the appropriate jack connectors and plug them in the corresponding sockets.

Note: Wire gauge is load dependent. Do not exceed relay contact's rating of 5 A / 250 Vac or 5 A / 30 Vdc, resistive load.

Alarm Relay Wiring

The alarm relay provides a contact closure which can be used as a switch to turn an external device on or off.

Note: Alarm contacts are form C rated 5 A / 250 Vac, 2 A / 30 Vdc, resistive load.
Fuse protected: 5 A / 250 V slow blow fuse.

Fail Safe Alarm Feature

The controller is equipped with the Fail Safe alarm feature to protect the process against critical errors arising from power interruptions, power surges and human errors.

The Fail Safe alarm feature resolves these predicaments on two fronts: hardware and software.

Hardware

To eliminate problems of blackout and line failure, the alarm function operates in a “Normally Closed” state and hence the alarm is triggered if the limits set are exceeded or when the power is down.

This is an important feature since with most controllers the alarm terminals close only when an abnormal situation arises; however, due to line interruption, no alarm condition occurs.

Software

Software is employed to set off the alarm in abnormal circumstances, e.g. if the control-dosing relay is On for too long a period. In both cases, the Alarm LED provides a visual warning.

Connect the external alarm circuit between the FS • C (Normally Open) and COM terminals to enter in Fail Safe mode.

Note: An alarm warns the user when the measured parameter exceeds the alarm thresholds; the power breaks down in case of a broken wire between the controller and the external alarm circuit.

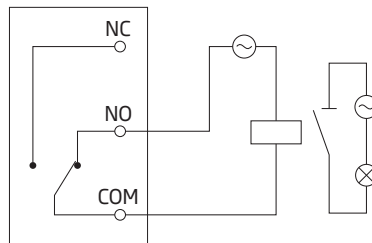

Figure 20: Connecting Alarm Circuit Between FS • C & COM Terminals

Note: In order to have the Fail Safe feature activated, an external power supply has to be connected to the alarm device.

Connecting the Power Supply



Qualified personnel should perform wiring only. The personnel must have read and understood the instructions in this manual when making power connection.

- Run the power cable through the power cable gland (Figure 14, label 5).
- Remove the power connector from the power board.
- Use a screwdriver to connect the cable leads to the jack power connector.

Note: Each leads location is marked on the power supply board.

- Insert the power connector in the power socket. See Figure 18. Replace safety cover over terminal 2.

4.2.4.2. Terminal 2 Wiring

Probe

1. Run the probe(s) cable through the conduit opening.
2. Connect the probe(s) leads to the removable terminal connector marked PROBE1 (PROBE2).
Follow the lead markings (+ positive / – negative) to ensure correct wiring position for output leads.
3. Carefully put the wired terminal connector into place on the board.
4. Position the excess cable through the cable gland, before tightening the nut.
5. Remove the screw and hardware located below PROBE1 (PROBE2) connector and attach ground lead (⊕).

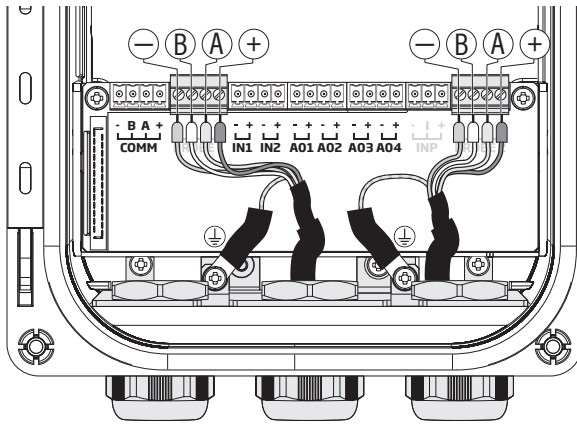

Figure 21: Probes Wiring

Probe cabling color code

Marking	Attached Cable	Patch Cable*	Functionality
–	GREEN	BLACK	0V
B	WHITE	WHITE	RS-485 D –
A	YELLOW	BLUE	RS-485 D +
+	BROWN	RED	5 V
⊕	GREEN / YELLOW		PROTECTIVE GROUND CONNECTION

* Cables may be purchased separately to connect between the probe and controller up to 50 meters (164 ft).

COMM

1. Run the communication cable through the left front conduit opening.
2. Connect the cable leads to the removable terminal connector marked COMM, using the marked lead locations.
3. After leads are fixed in the terminal connector, carefully put the wired terminal connector into place on the board.

Keep connection between COMM terminals and cable trunk as short as possible. Recommended use of 120 Ω / 0.5 W End Of Line Resistor (EOLR), if HI520 is the last device connected to a RS-485 Bus cable.

4. Feed excess cable through the cable gland before tightening nut.

Digital Input

The controller has two digital inputs (IN1 and IN2) that may be used to activate a signaled HOLD and /or a cleaning function.

1. Run the Input cable through the right front conduit opening.
2. Connect the cable leads to the removable terminal connector marked IN1 or IN2, using the marked lead locations. Pay attention to polarity. See [Figure 19](#) for power requirements.
3. After leads are fixed in the terminal connector, carefully put the wired terminal connector into place on the board.
4. Feed excess cable through the cable gland before tightening the nut.

Analog Output

The controller has up to four analog outputs. For setup information see **10.2 Analog Outputs** section.

1. Run the Analog Output cable through the right front conduit opening along with Digital input IN1 and IN2 cables.
2. Connect the cable leads to the removable terminal connector marked AO1 – AO4, using the marked lead locations. Pay attention to polarity.
3. After leads are fixed in the terminal connector, carefully put the wired terminal connector into place on the board.
4. Feed excess cable through the cable gland before tightening nut.

4.3. STARTING-UP THE CONTROLLER

At start-up, with probe(s) wired correctly, while the controller performs internal checks, the display will show the Hanna Instruments logo, controller name, and firmware version.



With new or no probe connected one of following warnings is displayed:

Message	Description
“No probe connected”	Connection issue or no probe connected.
“Different probe. Please set control parameters.”	Different probe type (series) connected.
“New probe. Update control settings if necessary.”	New probe (same series) connected.





A “Startup delay” message, associated with a programmable countdown timer indication, is displayed at power on.





Startup delay	5min
CH1 ▶	6.43 ^{pH} 25.0 ^{°C}
CH2	401 ^{mV} 25.0 ^{°C}

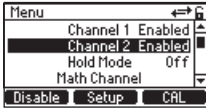
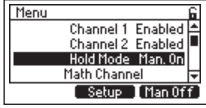
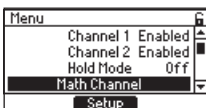
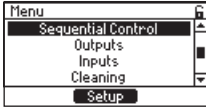
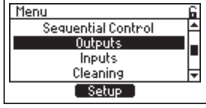
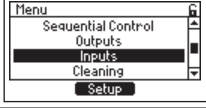

Note: During Startup delay, control is not started.

5. CONTROLLER SETUP – MENU STRUCTURE

The MENU key –  – is used to access menus for programming control functions and calibrating the controller.

- Press  from the live reading display to access the top-level Menu items.
- Press   to navigate items.
- Press  to return to previous hierarchical structure.
- Press **Setup** virtual key to enter a Menu item or access Probe, Control and Alarm settings.

Menu item	Screenshot	Function
CHANNEL (1 or 2)		Enable (Disable) selected channel Enter probe user calibration (CAL) Access channel setup (probe, control and alarm settings)
HOLD MODE		Activate (deactivate) manual Hold function Configure (view) input Hold parameters
MATH CHANNEL		Configure mathematical functions i.e. Difference, Ratio, % Passage, % Rejection (wired probes must have same measurement profile) Configure alarms (Low and High)
SEQUENTIAL CONTROL		Configure channel control
OUTPUTS		Configure analog outputs and relays
INPUTS		Configure or view digital inputs status
CLEANING		Start or stop cleaning cycle Configure or view cleaning parameters
TECHNICAL MENU		Calibrate Pressure and Analog outputs Update the controller's Firmware
MANUAL MODE		Directly drive the relays or analog outputs

Manu item	Screenshot	Function
LOG RECALL		Access logged data and transfer files to USB stick
GENERAL		Configure or view general settings (e.g. log interval, password, date and time, language selection, setting RS-485 communication parameters, setting controller ID)

6. CHANNEL



When Channel is selected **Disable (Enable)**, **Setup**, **CAL** virtual keys are visible.

- Press **CAL** to open the probe calibration menu
- Press **Setup** to open a process control submenu: Probe Settings, Control Settings, Alarm Settings

6.1. PROBE SETTINGS NAVIGATION

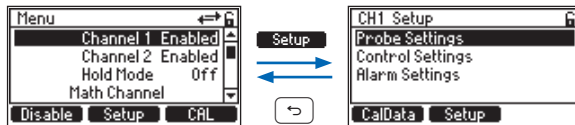
- Press the  key from the Measure mode.
- Select **Setup** with Channel (1 or 2) highlighted.
- Select **Setup** with Probe Settings highlighted.



- Press the   keys to navigate between parameters.
 - Select from virtual keys **View**, **Set**, or **Modify**.
- Press the  (back) key to return to the menu without saving.

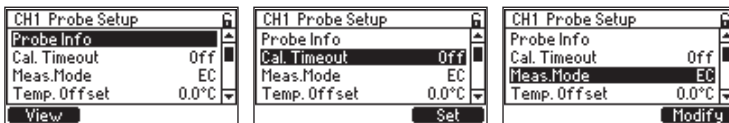

- At prompt, enter the passcode.
- At prompt, press **YES**, to place unit in HOLD.

Note: The controller validates the configured Setup when attempting to exit menu and directs the user to any invalid parameters. At prompt to save changes, press virtual key **YES**.

6.2. PROBE SETTINGS, GENERAL PARAMETERS

This section groups configurable Probe Settings items common to all wired probes regardless of measured parameter as well as probe information details.

Calibration timeout, Temp. source, Manual Temperature Value, setting the **temperature Offset** value follow the same steps regardless of wired parameter.

pH screens only are referenced as examples here. Information screens are probe specific.

For parameter-specific information on configurable options please refer to the following sections:

- ▶ 21 Measuring with pH & ORP Probes
- ▶ 22 Measuring with EC Probes
- ▶ 23 Measuring with Galvanic Dissolved Oxygen (DO) Probes
- ▶ 24 Measuring with Optical Dissolved Oxygen (DO) Probes

Probe Info

Option: Model, Firmware, Serial No.(number), Factory cal.(calibration)

Example of probe information screen with wired pH probe.

Probe Info	
Model:	HI1006-18
Firmware:	1.03
Serial No.:	P02170999111
Factory cal.:	2022-04-14

Calibration Timeout (Cal. Timeout)

Option: Disabled, 1 to 99 days

- With Cal. Timeout selected, press **Set**, to modify.
- Press the **▲** **▼** keys to modify the flashing value and press **CFM** to save.
- Cal. Timeout is used to send a reminder to recalibrate the probe. "!" is displayed in the Title & Status area.
Press the **?** **DIAG** key to access calibration message.

CH1 Probe Setup	
Probe Info	
Cal. Timeout	Off
Resolution	0.01pH
Temp. Offset	0.0°C
Set	





Temp. Offset & Temperature Calibration Procedure

Option: -5.0 to 5.0 °C, -9.0 to 9.0 °F

- With Temp. Offset selected, press **Set**.
- Press the **▲** **▼** keys to modify the flashing value and press **CFM** to save.
A positive value adds to the displayed temperature.
A negative value decreases the displayed temperature value.
- To obtain the temperature offset, see step 3, Temperature Calibration Steps.

CH1 Probe Setup	
Probe Info	
Cal. Timeout	Off
Resolution	0.01pH
Temp. Offset	0.0 °C
Set	

Temperature Calibration Steps

1. Place the probe and a reference thermometer (with 0.1 ° resolution) into a stirred container of water.
2. Observe the temperature on display until it stops changing. This may take several minutes.
3. Calculate the Temp.Offset (i.e. reference thermometer temperature minus probe temperature).
4. Press  from the Measure mode.
5. Select **Setup** from Channel parameter.
6. With Probe Settings selected, press **Setup**.
7. At prompt, enter the passcode.
8. Press the   keys to scroll to Temp.Offset, then **Set**.
9. At prompt, press **YES**, to place unit in HOLD.
10. Adjust blinking digits to the Temp.Offset calculated at step 3. Press **CFM**.
11. Press  to exit, and at prompt to confirm the change.

Temp. Source and Manual Temperature Value

The probe provides an accurate temperature used for temperature compensation and measurement.

In the event the temperature sensor inside the probe experiences a failure or other issue, the control process may continue using a manual temperature which should be set close to the process's temperature. A "!!!" is displayed. We suggest to order a replacement probe as soon as this occurs.

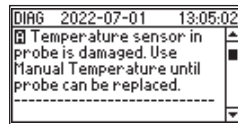
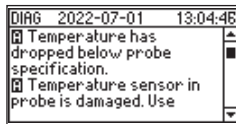
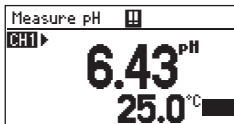

CalData

To access the CalData display option:



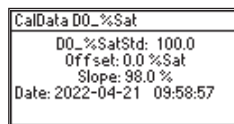
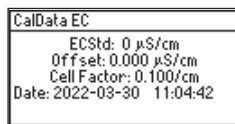
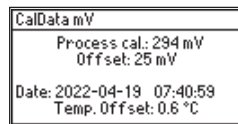
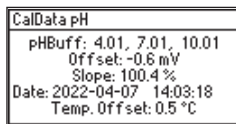
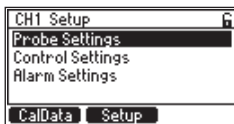

- Press **Menu** while in Measure mode, followed by **Channel Setup, Probe Settings**. The **CalData** key is displayed.
- Press **CalData** and the last detailed calibration data is displayed along with the date and time of the calibration and temperature offset.



6.3. (PROCESS) CONTROL SETTINGS & ALARM SETTINGS

Control and **Alarm Settings**, part of process-control system, are grouped under Channel menu item. HI520 operates a control-loop system whereby users have the option to run channel control independently (CH1 or CH2) or configure to be triggered sequentially upon reaching the other channel's set point(s) (1, 2, or both). This submenu is used to define the process control parameters.

Navigation

- Press the  key from the Measure mode.
- Select **Setup** from Channel (CH1 or CH2) parameter.
- Select **Setup** with Control Settings highlighted.
- Press the   keys to move between parameters.
- Press the  key to return to the menu without saving.

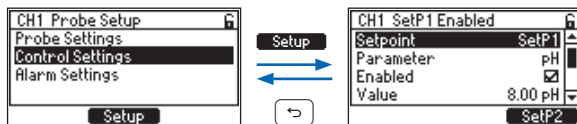

Note: We suggest users make configuration changes from the beginning of the menu structure going forward, because the menu references parameters that were set earlier in the submenu.

- At prompt, enter the passcode.
- At prompt, press **YES** to place unit in HOLD.

6.3.1. Configurable Control Parameters

Control parameters are measurement specific. Following examples are given with a wired **pH** probe, however, actual units will depend on the probe connected and on the probe configuration e.g. mode, units.

Setpoint

Option: SetP1, SetP2

With Setpoint selected, press **SetP1** (setpoint 1). Start with **SetP1** selection.

Repeat the entire process with **SetP2**, if desired.

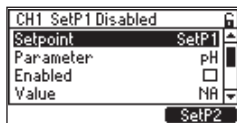

Parameter

Option: see [2.2 Supported Probe Series Configurations](#) for supported parameters

Parameter, measurement units, minimum and maximum probe values, Hysteresis, Deviation, Dead Band values, Control Period, Reset Time, Rate Time, Dead Band Gain depend on configured Control Mode option (i.e. ON/OFF, Proportional, PID) in Probe Settings submenu.

With Parameter selected, press the virtual key, and press the  key to save or  key to move to next parameter.

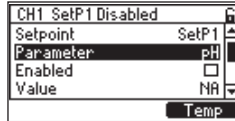

Enabled

Set point option has to be enabled to set up the Control function.

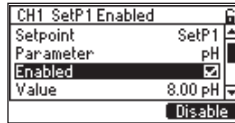

With Enabled selected, press **Enable** or **Disable**. A check mark will appear to confirm selection.

Press the  key, to exit or  key to move to next parameter.



Value

This parameter defines the Setpoint value. Setpoint must be enabled first

- With Value selected, press **Set**.
- Press the   keys to edit the required value within minimum / maximum probe limits (e.g. 0.00 to 12.00 pH), displayed blinking.
- Press **CFM**, to save.

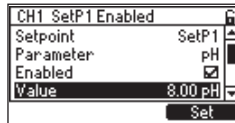

Note: A Control Setpoint value cannot be the same as the Alarm Setpoint.

Mode (Setpoint must be enabled first)



Option: ON/OFF, Prop., PID

The Mode parameter defines the type of control the controller will use i.e.ON/OFF, Prop., or PID.

The **Setup** virtual key is used after selecting **Mode**, to set additional settings.

See [18 Control Modes & Algorithms](#) for detailed information.

 Navigation

- Press **Modify** to open the drop-down list for Mode.
- Press the   keys to select mode type.

- Press **Select** to save.
- After selecting **Mode**, press **Setup**.

Setup for ON/OFF control

- Press **Setup** for the options submenu to be displayed.
- Press the **▲** **▼** keys to move between Mode and Hysteresis.

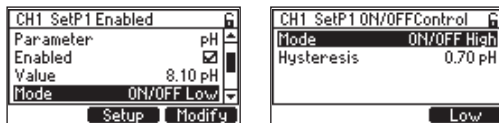

- Select Mode and press the virtual keys to select **ON/OFF Low** or **ON/OFF High**.
- Press the **▼** key, to select **Hysteresis**.
- With Hysteresis highlighted, press **Set**. The present value will blink permitting editing using the **▲** **▼** keys.

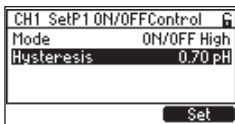

- Press **CFM** to save.
- Press the **↩** key, to exit Setup.

ON/OFF control. Hysteresis default and boundary values.

Control parameter	Measured parameter	Default	Minimum	Maximum *
Hysteresis	pH	1.00 pH	0.02 pH	1.2 pH
	ORP	50 mV	2 mV	400 mV
	EC	1.000 mS	0.002 μ S	100.0 mS
	DO	50 %Sat	0.2 %Sat	60.0 %Sat

* Maximum limit can be different from given values depending on probe measurement range (0.1 %).

Setup for Prop. Control



- Press **Setup** for the options submenu to be displayed.
- Press the **▲** **▼** keys to move between Mode, Deviation, Control Period, and Dead Band.

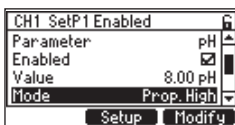

- Select Mode and press the virtual keys to select **Prop. High** or **Prop. Low**.

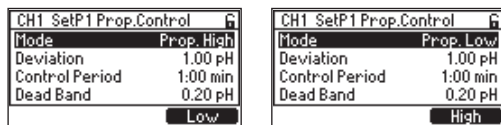

- Press the ∇ key to select **Deviation**.
- With Deviation highlighted, press **Set**. The present value will blink permitting editing using the \blacktriangle \blacktriangledown keys. Press **CFM** to save.

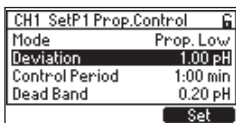

- Press the ∇ key, to select **Control Period**.
- With Control Period highlighted, press **Set**. The present value will blink permitting editing using the \blacktriangle \blacktriangledown keys. Press **CFM** to save.

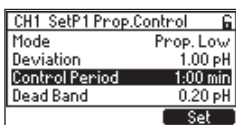

- Press the ∇ key, to select **Dead Band**.
- With Dead Band highlighted, press **Set**. The present value will blink permitting editing using the \blacktriangle \blacktriangledown keys. Press **CFM** to save.

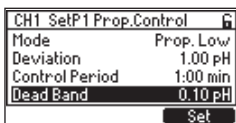

- Press the \rightarrow key, to exit Setup.

Prop. control. Editable default and boundary values.

Control parameters	Measured parameter	Default	Minimum	Maximum *
Deviation	pH	1.00 pH	0.02 pH	6 pH
	ORP	50 mV	2 mV	2000 mV
	EC	2.000 mS	0.002 μ S	500.0 mS
	DO	5.0 %Sat	0.2 %Sat	300.0 %Sat
Control Period		1.00 minute	10 seconds	30.00 minutes

* Maximum limit can be different from given values depending on probe measurement range (0.5 %)

Prop. control. Editable default and boundary values.

Control parameters	Measured parameter	Default	Minimum	Maximum *
Dead Band	pH	0.20 pH	0.00 pH	5 % of measured range but no more than Deviation value divided by 5
	ORP	10 mV	0 mV	
	EC	400.0 μ S	0.000 μ S	
	DO	20 %Sat	0.0 %Sat	

* Maximum limit can be different from given values depending on probe measurement range (0.5 %)

Setup for PID control

- Press **Setup** for the options submenu to be displayed.
- Press the **▲** **▼** keys to move between Mode, Deviation, Control Period, Reset Time, Dead Band, and Dead Band Gain.

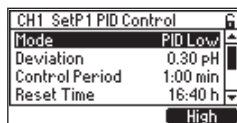
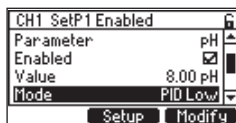

- Mode: press the virtual keys, to choose **PID Low** or **PID High**.

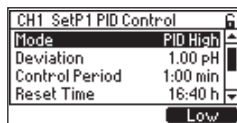
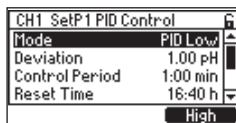

- Press the **▼** key, to select **Deviation**.
- With Deviation highlighted, press **Set**. The present value will blink permitting editing using the **▲** **▼** keys.

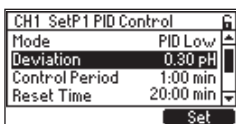

- Press **CFM**, to save.
- Press the **▼** key, to select **Control Period**.
- With Control Period highlighted, press **Set**. The present value will blink permitting editing using the **▲** **▼** keys.

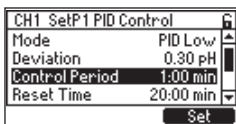

- Press **CFM** to save.
- Press the **▼** key to select **Reset Time**.

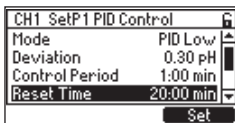

- With Reset Time highlighted, press **Set**. The present value will blink permitting editing, within the boundary values, using the **▲** **▼** keys. The default value disables the Integrative contribution.
- Press the **▼** key to select **Rate Time**.
- With Rate Time highlighted, press **Set**. The present value will blink permitting editing, within the boundary values, using the **▲** **▼** keys. The default value disables the Derivative contribution.

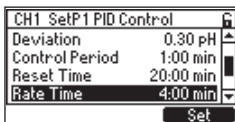

- Press **CFM** to save.
- Press the **▼** key to select **Dead Band**.
- With Dead Band highlighted press **Set**. The present value will blink permitting editing, within the boundary values, using the **▲** **▼** keys.

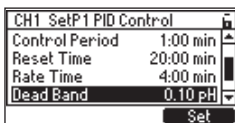

- Press **CFM** to save.
- Press the **▼** key, to select **Dead Band Gain**.
- With Dead Band Gain highlighted, press **Set**. The present value will blink permitting editing, within the boundary values, using the **▲** **▼** keys.

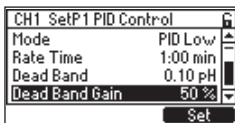

- Press **CFM** to save.

PID control. Editable default and boundary values.

Control parameters	Measured parameter	Default	Minimum	Maximum
Deviation	pH	1.00 pH	0.02 pH	6 pH
	ORP	50 mV	2 mV	2000 mV
	EC	2.000 mS	0.002 μ S	500.0 mS
	DO	100.0 %Sat	0.2 %Sat	300.0 %Sat
Control Period		1.00 minute	10 seconds	30.00 minutes
Reset Time		16:40 hours	10 seconds	16:40 hours

PID control. Editable default and boundary values.

Control parameters	Measured parameter	Default	Minimum	Maximum
Rate Time		0 seconds	0 seconds	16:40 hours
Dead Band	pH	0.20 pH	0.00 pH	5 % of measured range but no more than Deviation value divided by 5
	ORP	10 mV	0 mV	
	EC	400.0 μ S	0.000 μ S	
	DO	20.0 %Sat	0.0 %Sat	
Dead Band Gain		0 %	0 %	100 %

Overtime (Setpoint must be enabled first)

Option: Disabled, 10 to 120 minutes

The overtime (safety timer) parameter is provided to set the maximum continuous time a relay running a pump or a valve is energized.

For a control that is running an On/Off algorithm and its output is a relay, this time is the continuous time the relay is On before an alarm is issued. The timer will run during the On relay period and is reset when the Set point is reached. If the timer period expires, the relay will deactivate and an Alarm condition will occur.

Note: Place the unit on Hold Mode (manual Hold) to suspend the alarm. Hold LED should be on. Exit Hold to reset the timer.

- With Overtime selected, press **Set**.
- Press the **▲** **▼** keys to edit value displayed blinking.
- Press **CFM** to save.

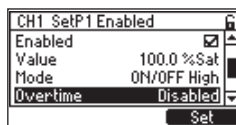
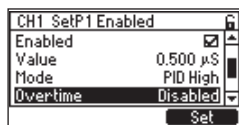
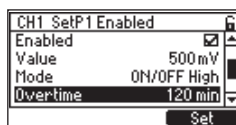
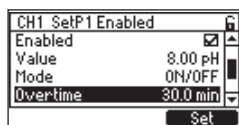

To reset an **Overtime Alarm**:

- Go to Menu, Hold Mode and select **Man On**. The Timer will reset to 0.
- Turn **off** the manual Hold before exiting menu.
- Verify the reagent tanks are full and pumps or valves used are operational.

Control Output (Setpoint must be enabled first)

Option: Read only

Displays the current relay (e.g. Relay1) associated with selected Set point.

If **Multiple** is displayed, press **View**, to display assigned relays or outputs.

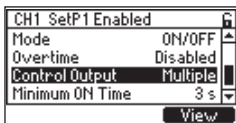

Minimum ON Time (Setpoint must be enabled first)

Option: 1 to 10 seconds

Allows users to control the speed of the relay status change when previously set conditions are met. This timer prevents the relay and connected device from “chattering” by forcing a minimum on and off time.

The flashing of the selected value indicates that it can be modified by using the ▲ ▼ keys.

With Minimum ON Time selected, press **Set**.

Press the ▲ ▼ keys to edit the value displayed blinking. Press **CFM** to save

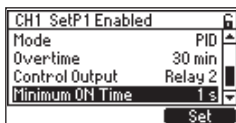
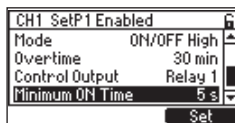



Note: The controller validates the configured Setup when attempting to exit menu and directs the user to any invalid parameters. At prompt to save changes, press virtual key **YES**.

6.3.2. Configurable Alarm Settings

This submenu is used to define the operating limits of the process. The setting thresholds configured in this submenu control the Alarm relay. If Alarm becomes active, control stops. Both measured parameter and Temperature are configured in this submenu.

Note: Alarm Menu items are measurement specific. Examples are given using **pH**, however, actual units will depend on the probe connected and on the probe configuration (e.g. mode, units etc).

 Navigation

- Press  key from the Measure mode.
- Press **Setup** from Channel parameter.
- Press **Setup** with Alarm Settings highlighted, and the alarm submenu will open.
- Press the ▲ ▼ keys to move between options.
- Press the back key () to return to the menu without saving.

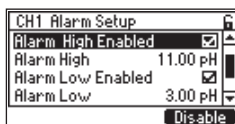

Note: We suggest users make configuration changes from the beginning of the menu structure going forward, because the menu references parameters that were set earlier in the submenu.

- ▶ At prompt, enter the passcode.
- ▶ At prompt, press **YES** to place unit in **HOLD**.

When completed, return to the “other” parameter and set that up also. Alarm can be configured for both measurement and Temperature.

Parameter

Option: see 2.2 Supported Probe Series Configurations for all available parameters.

With Parameter selected, press the corresponding virtual key to toggle between options.

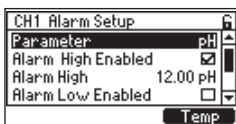

Alarm High Enabled

Option: Enabled, Disabled

- With Alarm High Enabled selected, press the corresponding virtual key to toggle between enable or disable options. The check mark confirms parameter is enabled.
- Press the key to save.



Alarm High (Alarm High Enabled must be checked first)

Allows users to set the upper-limit value for the alarm.

- To modify the value, with Alarm High selected, press **Set**. The flashing digit indicates that value can be modified. Press the keys, to modify.
- Press **CFM**, to save. Once confirmed, the value stops flashing.
- Press the key to return to the menu.

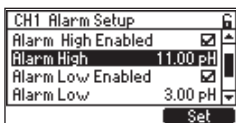

Note: A Control Setpoint value cannot be the same as the Alarm Setpoint.

Alarm Low Enabled

Option: Enabled, Disabled

- With Alarm Low Enabled selected, press the corresponding virtual key to enable or disable. The check mark confirms parameter enabled.
- Press the key, to save.



Alarm Low (Alarm Low Enabled must be checked first)

Allows users to set the lower-limit value for the alarm.

- To modify the value, with Alarm Low selected, press **Set**. The blinking of the selected value indicates that value can be modified by using the ▲ ▼ keys.
- Press **CFM**. Once confirmed, the value stops flashing.
- Press the ↵ key, to return to the menu.

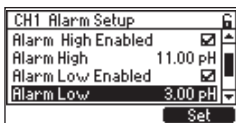

Mask Time (Alarm High Enabled or Alarm Low Enabled must be checked first)

Option: 0 to 30 minutes (0-59 seconds, 1:00 to 30:00 minutes)

Mask time is an Alarm delay timer. If alarm condition is detected, alarm will become active after "Mask time" units of time before activating the alarm.

- Press **Set**, to modify the value. The flashing value indicates that it can be modified.
- Press the ▲ ▼ keys followed by **CFM**, to save. Once confirmed, the value stops flashing.
- Press the ↵ key to return to the menu.

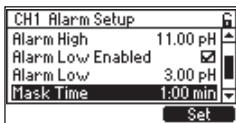

Delay Off Time (Alarm High Enabled or Alarm Low Enabled must be checked first)

Option: 5 to 999 seconds

Delay Off Time is an off delay timer. Once the alarm becomes inactive from alarm condition point of view it still remains active for "Delay Off Time" units of time.

- Press **Set** to modify.
- Press the ▲ ▼ keys to modify the flashing value.
- Press **CFM** to save. Once confirmed, the value stops flashing.
- Press the ↵ key to return to the menu.

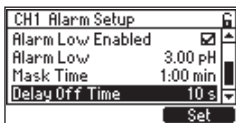

Note: The controller validates the configured Setup when attempting to exit menu and directs the user to any invalid parameters. At prompt to save changes, press **YES**.

7. HOLD MODE

Note: Setup selections do not change if a new parameter probe is used on controller.

When Hold Mode is selected, **Man. On** or **Man Off** virtual keys are visible.

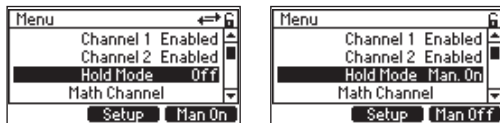

7.1. TURNING ON MANUAL HOLD

The Hold Mode submenu is used to turn on or off a manual Hold. It can also be used to configure a remote hold feature that uses a digital Input Trigger.

1. Select **Man. On**.
2. The state next to the Hold menu item changes to **Man On**.
3. Press the key, to exit the parameter.

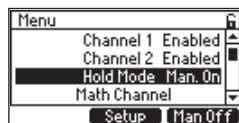

When in Manual Hold:

- Hold is displayed in the Title & Status area.
- The primary measurement value is displayed blinking.
- The HOLD LED is on.
- Any relay configured for Hold; relay LED will be on with associated relay enabled.
- All the alarm signals (LED, alarm relay) are suspended.
- Analog Outputs will be at configured state (see 10.2 Analog Outputs).

7.2. CONFIGURING EXTERNAL HOLD TRIGGER

Navigation

- From Menu, use keys to select Hold Mode, Man. On.
- With Hold Mode, Man. On configured, press **Setup**, to enter the screen.

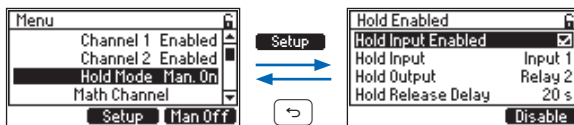

Hold Input Enabled

Option: Enabled, Disabled

With function selected, press **Enable (Disable)** to toggle between the two options. The check mark confirms Hold Input enabled.

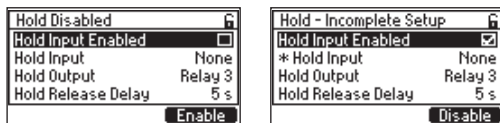

Hold Input

Hold mode can be triggered using external trigger inputs. This is a read-only parameter that indicates what Inputs are configured to initiate Hold mode. If an input is selected, the selected input is displayed.

- To change the input assignment for Hold Input, return to the top level Menu structure and select Inputs.
- To return to the menu without changing, press the  key.

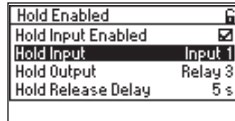

Hold Output

This is a read-only parameter that indicates what relay outputs (if any) are configured to Hold mode. To return to the menu without changing, press  key.

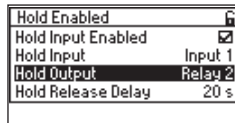

Hold Release Delay

Option: 0 to 99 seconds

Hold Release Delay is a timer that allows control function to remain in a HOLD state for additional time after the HOLD is released. This time will be counted down and displayed on the Title & Status area.

With Hold Release Delay selected, press **Set** to modify.

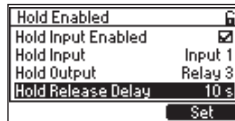

At prompt, enter the passcode.

The time value flashes, indicating that it can be modified. Press the   keys to adjust the value.

Press **CFM**, to save or press the  key, to return to the menu without saving.

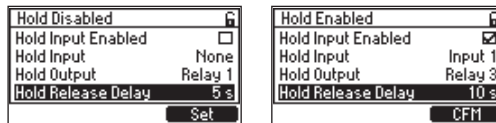

Note: The controller validates the configured Setup when attempting to exit Menu and directs the user to any invalid parameters. At prompt, to save changes, press **YES**.

8. MATH CHANNEL

Match channel displays the mathematical result of the measurement between two probes with identical measurement configuration and unit.

Channel can only be configured when:

- Both probes are connected and initialized
- Both probes are of the same type (pH, ORP, EC, DO) have same Measure Mode, and Measurement Unit

Notes: Channel data is not logged in the data Log files.

Channel alarms set neither CH1 control nor CH2 control on Hold, when enabled and activated.

Channel & function availability by parameter

Function	pH	ORP	EC						DO	OPDO
			EC	TDS	RES	Sal%	Sal ppt	Sal psu		
Difference	<input checked="" type="checkbox"/>	<input checked="" type="checkbox"/>	<input checked="" type="checkbox"/>	<input checked="" type="checkbox"/>	<input checked="" type="checkbox"/>	<input checked="" type="checkbox"/>	<input checked="" type="checkbox"/>	<input checked="" type="checkbox"/>	<input checked="" type="checkbox"/>	<input checked="" type="checkbox"/>
Ratio	<input checked="" type="checkbox"/>	<input checked="" type="checkbox"/>	<input checked="" type="checkbox"/>	<input checked="" type="checkbox"/>	<input checked="" type="checkbox"/>	<input checked="" type="checkbox"/>	<input checked="" type="checkbox"/>	<input checked="" type="checkbox"/>	<input checked="" type="checkbox"/>	<input checked="" type="checkbox"/>
% Passage	<input checked="" type="checkbox"/>	<input checked="" type="checkbox"/>	<input checked="" type="checkbox"/>	<input checked="" type="checkbox"/>	<input checked="" type="checkbox"/>	<input checked="" type="checkbox"/>	<input checked="" type="checkbox"/>	<input checked="" type="checkbox"/>	<input checked="" type="checkbox"/>	<input checked="" type="checkbox"/>
% Rejection	<input checked="" type="checkbox"/>	<input checked="" type="checkbox"/>	<input checked="" type="checkbox"/>	<input checked="" type="checkbox"/>	<input checked="" type="checkbox"/>	<input checked="" type="checkbox"/>	<input checked="" type="checkbox"/>	<input checked="" type="checkbox"/>	<input checked="" type="checkbox"/>	<input checked="" type="checkbox"/>

8.1. MATH CHANNEL SETUP

Navigation

- From Menu, use keys to select Math Channel.
- Use Math Channel submenu to enable math function.

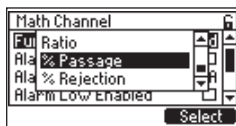
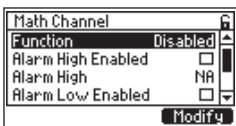

Math functions

Function	Formula	Range	Default Alarm Low	Default Alarm High
Difference	$(a - b)$	- PHL to +PHL	- PHA	+ PHA
Ratio	(a / b)	0.0 to 500.0	0.0	100.0
% Passage	$(a / b) \times 100$	0.0 % to 500.0 %	0.0 %	100.0 %
% Rejection	$[1 - (a / b)] \times 100$	- 500.0 % to + 500.0 %	0.0 %	100.0 %

a = main Measurement (CH1)
b = main Measurement (CH2)

PHL = Probe High Limit

PHA = Probe High Alarm

Low and High alarms can be set on the channel.

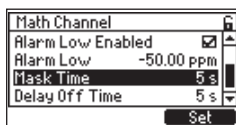
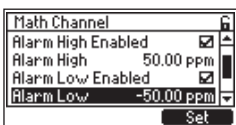
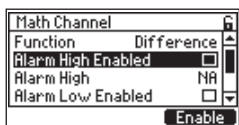

8.2. MATH CHANNEL MEASUREMENT

From measurement screen, use \blacktriangle \blacktriangledown keys to display result of configured math function.

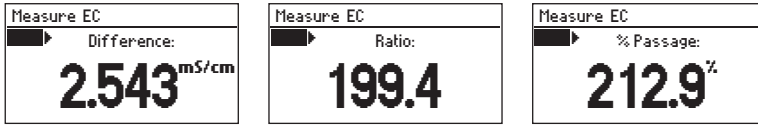

9. SEQUENTIAL CONTROL

HI520 operates a control-loop system whereby users have the option to run channel control independently or configure to be triggered sequentially upon reaching the other channel's set point(s) (1, 2, or both).

Navigation

- From Main Menu, use the \blacktriangle \blacktriangledown keys to select Sequential Control.
- With item highlighted, press **Setup**.
- Use the \blacktriangle \blacktriangledown keys to select channel control (CH1 or CH2).
- Press **Modify** followed by **Select** to configure channel control loop.

- Independent** – control runs independently and controller is converted to single channel mode
- SetP1** – the control loop works when SetP1 is reached
- SetP2** – the control loop works when SetP2 is reached
- SetP1 & 2** – the control loop works when SetP1 and SetP2 are reached

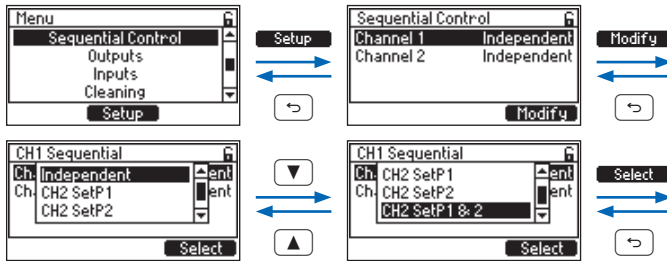

10. OUTPUTS

Navigation

- From Main menu, press the \blacktriangle \blacktriangledown keys to select Outputs. With Outputs selected, **Setup** virtual key is visible.
- Press **Setup** to open a submenu structure that includes Relays and Analog Outputs.



- Press the \blacktriangle \blacktriangledown keys to toggle between them and press **Setup**, to open the selected parameter.
- At prompt, enter the password.
- At prompt, with the password enabled, press **YES**, to place unit in HOLD and start modifying parameters.

Relays and Analog Outputs can be used as part of a process control system.

Relay contacts are connected to control elements e.g. valves, pumps, motors used for process value regulation. They are also used to interface with automated probe cleaning devices.

Analog Output signals are interfaced with supervisory control and automation systems or to a simple chart recorder to capture process measurements.

Note: Controller model determines the number of relays and analogs.

10.1. RELAYS

Navigation

- With Outputs menu item selected, press **Setup**.
- Use the **▲** **▼** keys to select Relays.

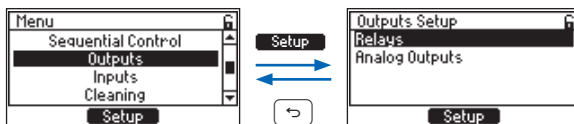

- Press **Setup** to open the list of Relays (with the type listed beside it). The relays can be assigned to the Set points, Hold, or Cleaning functions.

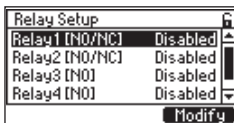

- Press the **▲** **▼** keys to move between the items.
- Press the **↩** key to return to the menu without saving.
- Press **Modify** to select the relay operating mode. Multiple relays can be allocated to the same function.



Note: HI520-0320 has 3 relays, 2 Analog Outputs (AO) & HI520-0540 has 5 relays, 4 Analog Outputs (AO).

Note: The controller validates the configured Setup when attempting to exit Menu and directs the user to any invalid parameters. At prompt, to save changes, press YES.

10.2. ANALOG OUTPUTS

Note: Controller model determines the number of relays and analogs.

Navigation

- From Analog Outputs, press **Setup**.
- Press the **▲** **▼** keys to navigate between parameters.

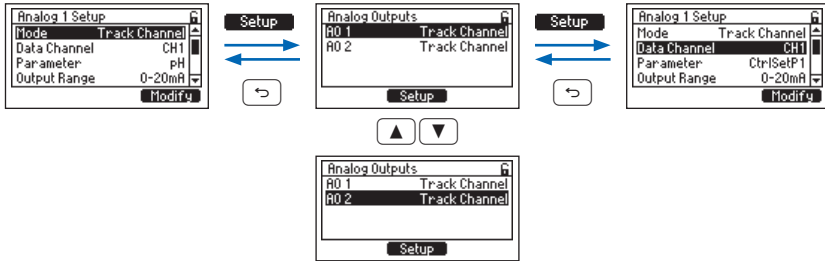

- Press the **↩** key to return to the menu without saving.
- At prompt, enter the passcode.
- At prompt, with the password enabled, select **YES** to place unit in HOLD and start modifying parameters

Note: We suggest users make configuration changes from the beginning of this Menu structure going forward, because of the menu references parameters that were set earlier in the submenu.

Mode

Option: Disabled, Track Channel

With Mode selected, press **Modify** to toggle options.

Disabled indicates that analog output has not been allocated to any function.

With Track Channel selected the analog output follows a specific parameter.

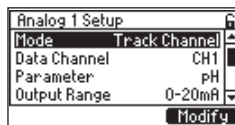

Data Channel

Option: CH1, CH2, Math channel

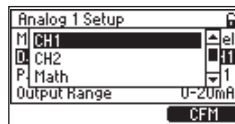
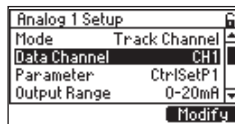

Parameter

Option: CtrlSetP1, CtrlSetP2, probe parameter reading, Temperature

With Parameter selected, press **Modify** and select the parameter from the available options. Press **Select** to save.

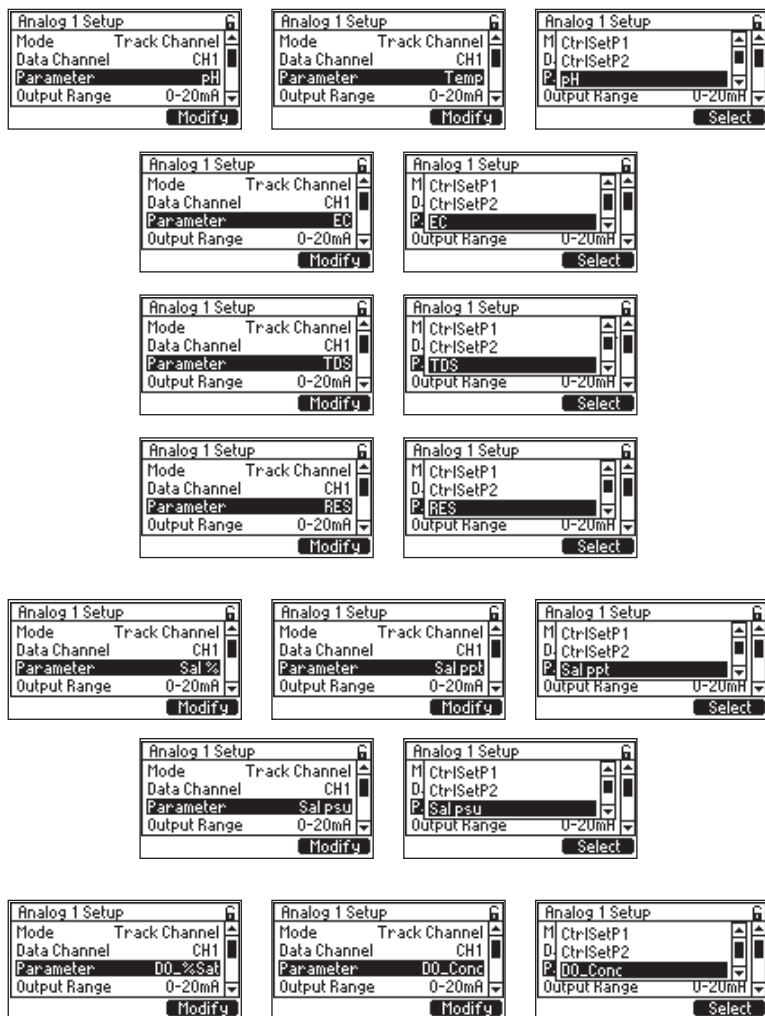

When analog output is assigned to CtrlSetPx, it will follow specific Set point control output.

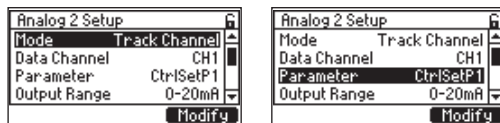

Output Range

Option: 0-20 mA, 4-20 mA

With Output Range selected, press the corresponding virtual key, to toggle mA output range: 0-20 mA or 4-20 mA.

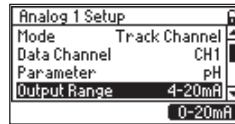
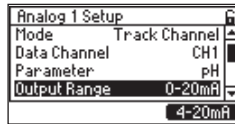

0 mA or 4 mA Value

Option: measured parameter, CtrlSetP1 or CtrlSetP2

- With 0 mA (or 4 mA) Value selected, press **Set**.
The value will flash indicating it can be modified.
- Press the **▲** **▼** keys to increase or decrease the value.
- Press **CFM** to save.

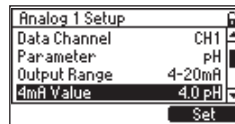
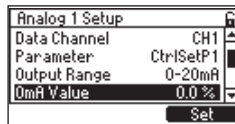

20 mA Value

Option: measured parameter, CtrlSetP1 or CtrlSetP2

- With 20 mA Value selected, press **Set**. The value will flash indicating it can be modified.
- Press the **▲** **▼** keys to increase or decrease the value.
- Press **CFM** to save.

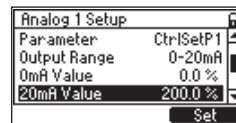
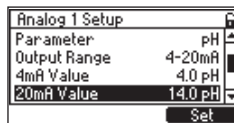
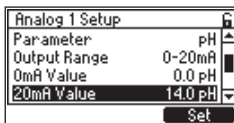

HOLD Value

Option: Last Frozen, Fixed Value

With HOLD Value selected, use the virtual key to toggle between FixedValue or LastFrozen.

Last Frozen indicates output being held at present level, prior to hold.

Fixed Value indicates output being driven to a configured value during hold.

Note: Value is set in the next parameter; Fixed Value.

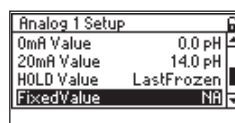
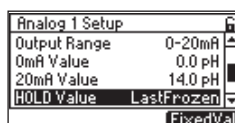

Fixed Value

- With Fixed Value selected, press **Set**. The value will flash indicating it can be modified.
- Press the **▲** **▼** keys to increase or decrease the value. Press **CFM** to save the value.
- Press the **↶** key to return to the menu.

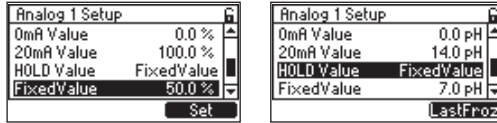

Out 22 mA - OnALARM

Option: Enabled, Disabled

With Out 22 mA -On ALARM selected press the corresponding virtual key to enable or disable function.

When enabled, it drives the analog output to 22 mA in an alarm condition.

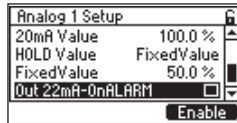

Note: The controller validates the configured Setup when attempting to exit Menu and directs the user to any invalid parameters. At prompt to save changes, press YES.

11. INPUTS

Note: Setup selections do not change if a new parameter probe is used on controller.

With Inputs selected press **Setup** to open a submenu structure for Input 1 and Input 2.

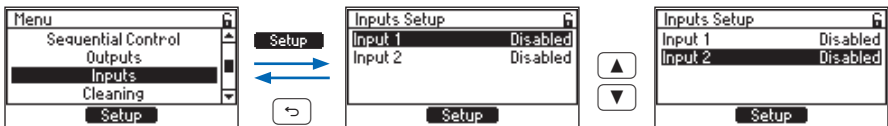

Both inputs are configured the same way. Verify the wiring before configuration.

Navigation

- From Main Menu, use the **▲** **▼** keys to select Inputs.
- Use the **▲** **▼** keys to toggle between options.
- With option selected, press **Setup**, to open the selected input.

If required:

- At prompt, enter the passcode.
- At prompt, press **YES** to place unit in HOLD.

Each of the two inputs can be configured as disabled or used to trigger Hold Mode or a Cleaning cycle from a remote trigger switch.

The active level of the input can be set High or Low.

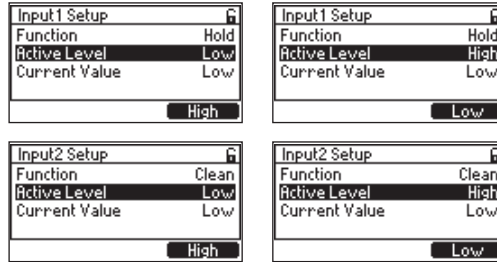

For modifying the operating mode for either input please follow the four-step procedure below:

1. With Input 1 (or Input 2) selected, press **Setup**.
2. Use the **▲** **▼** keys to navigate between options.

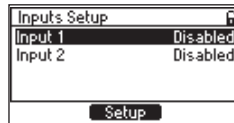

3. Press **Modify**, for the Function drop-down list to display.
4. Use the **▲** **▼** keys to move between the three options and press **Select** to confirm.

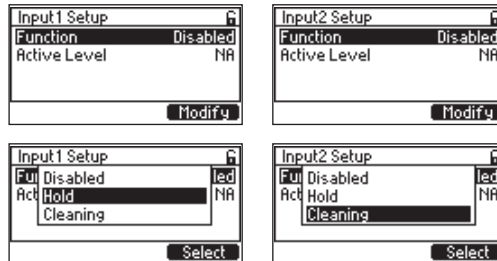

Note: The controller validates the configured Setup when attempting to exit Menu and directs the user to any invalid parameters. At prompt to save changes, press virtual key **YES**.

12. CLEANING

Note: Setup selections do not change if a new parameter probe is wired.



The cleaning menu is used to program a time-controlled cleaning function that uses the configured relays to activate valves, pumps or compressed air to automate probe cleaning.

Two types of cleaning may be programmed: **Simple** and **Advanced**.

Simple cleaning is suitable for any application in which the automated use of water flushing or a directed air stream is sufficient as a cleaning medium. A jet of water or air is directed toward the probe tip, and deposits are loosened and swept away. The flushing typically occurs directly in the process.

Advanced cleaning supports the use of two programmable relays. One for the rinse or flushing with water, and a second to activate a valve or pump for chemical cleaning agent.

Cleaning Cycle & Rinse Relay Configuration (during cycle)

- Cleaning cycles can be initiated manually by digital input, timer (programmed interval), or by scheduling.
- The frequency and duration of the cleaning cycle can be programmed to meet the requirements of the particular application.
- With Advanced cleaning is selected, long press (a few seconds) the   keys simultaneously to stop a cleaning cycle manually. The cleaning is stopped but the cycle will complete the rinse and recovery phases before returning to the measurement or process control.
- Calibration cannot be started when Simple or Advanced cleaning is in progress.
- Cleaning can not be triggered while calibration is being performed.
- Automatically cleaning the process probe can be seen as a disruption of the normal measuring or control modes. As the cleaning cycle starts, the controller is placed in HOLD mode.
- Rinse relay configuration

Simple cleaning: the configured rinse relay is activated, through the rinse time, followed by a recovery time as the probe system is reacquainted to the process; the cleaning cycle ends and the controller returns to the normal Measure and Control service.

Advanced cleaning: the configured rinse relay is activated and remains on throughout the cleaning. After the pre-wash rinse time has expired, the second wash relay is on for the wash time. As this time expires, the post-wash rinse timer starts followed by a recovery timer as the probe system is reacquainted to the process; then the cleaning cycle ends and the controller returns to the normal Measure and Control service. This rinse or wash cycle can be repeated multiple times, as desired.

Navigation

- From Main Menu, press the   keys to select Cleaning.
- Press **Start** to start a cleaning cycle.

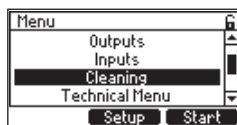
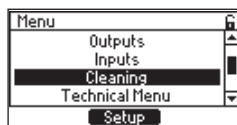

- With Cleaning selected, press **Setup** to enter screen.

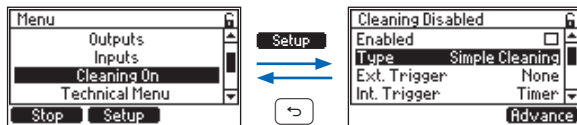

- At prompt, enter the passcode.
- At prompt, press **YES** to place unit in HOLD.
- Enabled* option has to be active (check mark displayed) for the rest of the configurable parameters to be modified.
- Use the **▲** **▼** keys to move between parameters.
- Press the **↩** key to return to the menu without saving.

Enabled

Option: Enabled, Disabled

With Enabled selected, press the corresponding virtual key to enable (activate) cleaning mode or disable cleaning mode.

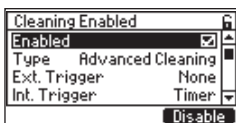

Type

Option: Simple, Advanced

With Cleaning Type selected, press **Advanced** or **Simple**, to toggle options.

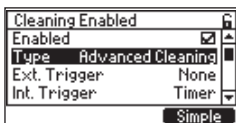

Ext. Trigger

Option: None, Input 1, Input 2

This is a read-only parameter that indicates what Input, if any, has been assigned to start cleaning.

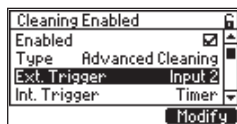
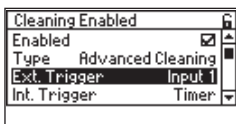
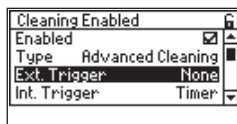

With two inputs configured, press **View** to display configured trigger input options.

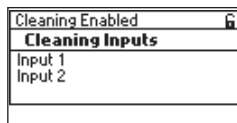
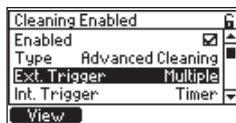

Int. Trigger

Option: Disabled, Timer, Schedule

- With Int. Trigger selected, press **Modify** for the drop-down options list to be displayed.
- Use the **▲** **▼** keys to scroll between options.
- Press **Select** to save option.

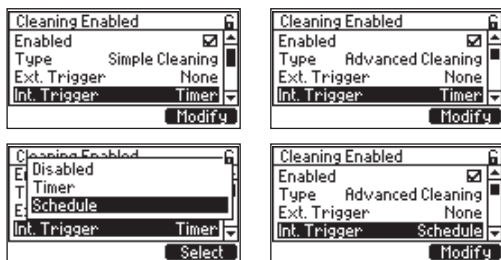

When set on Timer, cleaning cycle will proceed following the time period set in the parameter Cleaning Interval.

Schedule

If Int. Trigger is selected, **options** are Disabled or Timer, NA will be seen.

If Int. Trigger is set to Schedule, **options** are On or Off.

- With Schedule On selected, press **Setup** to configure a cleaning schedule.
- Set up to three start times per day for the cleaning cycle to start.
- Enable the days of the week for the cleaning cycle to be done.
- Press the **↵** key to save and exit schedule.

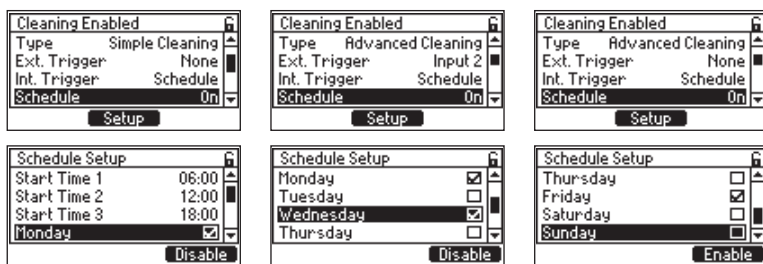

Cleaning Interval

Option: 1 to 1440 min. (as 1 to 59 min. and 1:00 to 24:00 h), if Timer is selected as an Int.Trigger
 NA, if Schedule is selected as Int. Trigger

- With Cleaning Interval selected, press **Set**, to modify.
- Use the **▲** **▼** keys to modify the flashing digit.
- Press **CFM** to save.

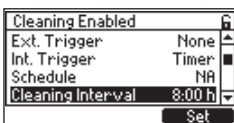

12.1. ADVANCED CLEANING

- With item selected, press **Set** to modify.
- Use the **▲** **▼** keys to modify the flashing digit. Press **CFM** to save.

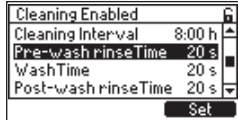
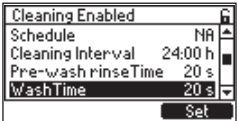
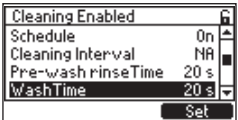
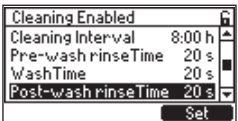
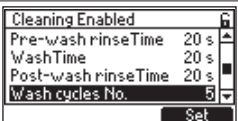
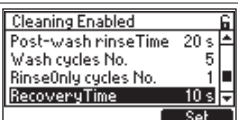
Item	Option	Screenshot
Pre-wash rinse Time	5 to 300 seconds	
Wash Time	5 to 300 seconds	
Post-wash rinse Time	5 to 999 seconds	
Wash cycles No.	1 to 10 cycles	
Rinse Only cycles No.	1 to 10 cycles	
Recovery Time Time period for probe to be reacquainted to the process before starting control	5 to 120 seconds	
Rinse Relay View-only parameter that indicates the configured relay(s) for the rinse function	Displays allocated rinse relay	
Wash Relay View-only parameter that indicates configured relay(s) for the wash function	Displays allocated wash relay	

12.2. SIMPLE CLEANING

- With item selected, press **Set** to modify.
- Use the **▲** **▼** keys to modify the flashing digit.
- Press **CFM** to save.

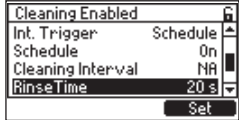
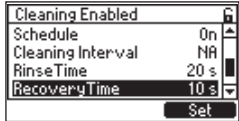
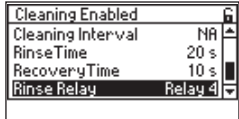
Item	Option	Screenshot
Rinse Time	5 to 300 seconds	
Recovery Time	5 to 120 seconds	
Rinse Relay	Displays allocated rinse relay	

Note: Controller validates configured Setup when attempting to exit Menu and directs the user to any invalid parameters. At prompt to save changes, press YES.

13. TECHNICAL MENU

The technical menu is used for on-site, single point pressure calibration (Press. Calibration), Analog Output calibration (AO Calibration) and firmware update.

Current pressure values are entered manually and reading is displayed in mmHg.

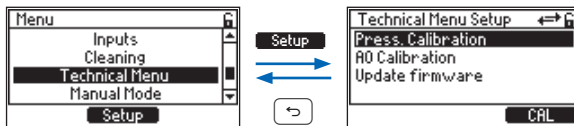

Navigation:

- Press the **☰** key from the Measure mode.
- With Technical Menu selected, press **Setup** to enter the screen.
- Use the **▲** **▼** keys to navigate options.
- With option highlighted, press the displayed functional key to start calibration or firmware update.

13.1. PRESSURE CALIBRATION

Repeated calibrations may be performed and the offset is added (within ± 100 mmHg limit) to the previous calibration. Use a hand held meter to determine the current pressure value.

Procedure

1. Press **CAL** to enter calibration mode.
At prompt, with the password enabled, input the passcode.
At prompt, select **YES** to place the unit in HOLD.
2. Actual pressure value is displayed on the LCD.

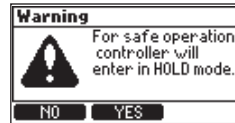
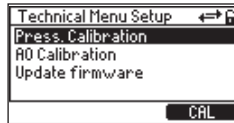

3. Press the **▲** **▼** keys to adjust the value to the one determined with the hand held meter.
4. When the reading is stable, **CFM** is displayed. Press **CFM** to save the calibration.

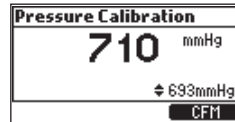

The controller returns to the Technical Menu Setup.

Clear Pressure Calibration

1. Press **CAL**, to enter calibration mode.
2. **CLR** option is displayed for a few seconds. Press **CLR** to clear a previous calibration.
3. Deletion confirmation screen is displayed. Press **YES** to confirm. The factory calibration value is displayed.

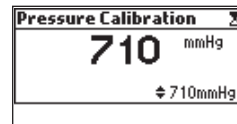
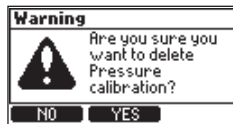
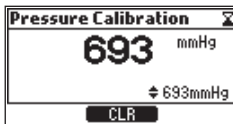

13.2. ANALOG OUTPUT CALIBRATION

Option: range from 4 mA to 20 mA

Procedure

1. Press **Setup** to enter Analog Output calibration screen.



2. At prompt, with the password enabled, input the passcode.
At prompt, select **YES** to place the unit in HOLD.
3. Press **Next** virtual key to navigate and select AO for editing. The \updownarrow symbol indicates selected AO.
4. Use the \uparrow \downarrow keys to adjust the first point calibration value for selected analog output.
5. Press **CFM** to save the calibration.
6. From the second point calibration screen, press **Next** virtual key to select AO line for editing and press the \uparrow \downarrow keys to adjust the second point calibration value for selected analog output.
7. Press **CFM** to save the calibration and return to Technical Menu Setup screen.

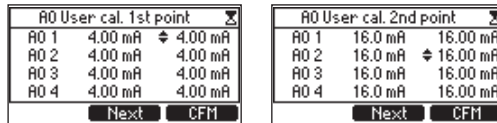

Clear AO Calibration

1. Press **CAL** to enter AO calibration screen. **CLR** option is displayed.
2. Press **CLR** to delete a previous calibration.
3. Press **Yes**, to confirm deletion.



13.3. FIRMWARE UPDATE

The controller firmware can be updated using an USB drive, following the procedure received from Hanna Instruments service team.

- Press **YES** to place the unit in HOLD.
- To export all log files to the USB drive, press **YES**.



Note: Back up logged data prior to update.

14. MANUAL MODE

When Manual Mode is selected, **Setup** is visible. Select **Setup** to open up Relays (with their configured function) and Analog Outputs submenu structure.

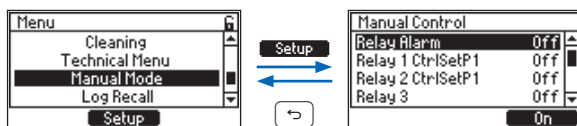

When relays are turned to on, it can manually test the relay connection and operation (relay contact opening and closing) and also the operation of the associated equipment, and is a useful feature to prime a dosing pump for example. The current loop(s) can be tested by setting a current value and verifying it at the outputs.

Navigation

- From Main Menu, press the **▲** **▼** keys to select Manual mode.
- With option selected, press **Setup** to enter the screen.
- Press the **▲** **▼** keys to move between the five relays and two or four analog outputs.

Relay Alarm

Option: On, Off

Relay set to be On, keeps its status for maximum 60 minutes before it switches Off; or user leaves Manual Mode.

Relay x

Option: On, Off

Relay set to be On, keeps its status for maximum 60 minutes before it switches Off; or user leaves Manual Mode.

Analog Output AO x

Option: 0.0 to 22.0 mA

1. In Manual Control screen, press the **▲** **▼** keys to move to AO x.
2. With AO x selected, press **Set**, to modify. Use the **▲** **▼** keys to modify the flashing digit.
3. Press **CFM**, to save. The analog remains at the current set for 60 min. until it resumes previous current value.

15. LOG RECALL

Select Log Recall item to open up measurement Log files and Event logs submenu.

15.1. MEASUREMENT LOG FILES

The readings for each measurement are automatically logged at configured time intervals.

A new log is started each time the instrument is calibrated or reconfigured.

Logged data include measured parameter and temperature values, last calibration data, setup configuration that includes Alarm and Control Setpoints, controller and probe FW.

The controller stores up to 100 logs displayed in a list, starting with the most recent one. Each Log can hold up to 8600 records / 860,000 total data points.

Example of displayed log name: 004.L2022-04-26 00

Example of saved .csv file: 220422600030.CSV

Where:

L stands for Log, ## is the log number for that day (00 through 99), and the interval is the logging interval used (i.e. 30 seconds given here).

YYMMDD ## Interval

See **Log Data Export to USB-C Flash Drive** section for log export details.

Navigation

- From main Menu, use the   keys to select Log Recall.
- With option selected, press **Select** to enter screen.



The controller creates a log file for each parameter and the logged files are saved in parameter-specific Lot Log folders.

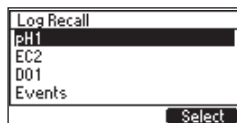

Lot Log

- Lot Log storage can hold a maximum of 100 files with a maximum of 8600 records per file.
- Logging interval can be set from 10 seconds to 180 minutes by following the path: Menu, General, Log Interval.
- At the selected interval, the following information is recorded:
 - ▶ Date
 - ▶ Time
 - ▶ Read value (pH, mV, EC, DO, TDS, RES, Salinity)
 - ▶ Temperature
 - ▶ Parameter-specific alarm
 - ▶ Temperature alarm
 - ▶ Set points alarm
 - ▶ Hold status
 - ▶ Probe reconnect status

- Log file header area displays:
 - ▶ Controller and Probe information
 - ▶ Control settings
 - ▶ Alarm settings
 - ▶ Log interval
- Once the 100 file limit has been reached, the current log file will overwrite the oldest one.
- To view additional information about the selected data point, press **Details**.
- Press virtual key **Option** to Export or Delete logs.

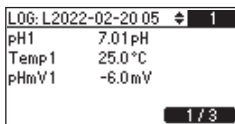
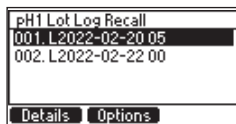

Log Data Export to USB-C Flash Drive

To export:

- Insert a USB-C flash drive (or USB-A with cable adapter) into the unit's USB-C connector.
- Use the keys to move between the options.
- With the USB-C flash drive plugged in, press **CFM** to save an action or the key to return to the menu without saving.

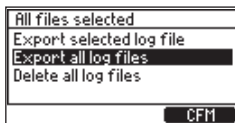
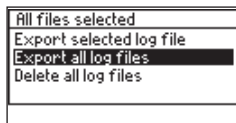

- The exported logs will be in a folder named **HI520-xxxx** (where x are the controller ID)

Note: Do not remove the USB flash drive during the file transfer. If an error occurs during transfer, "Error while transferring" is displayed. Reinstall the flash drive and try again.

Data Management

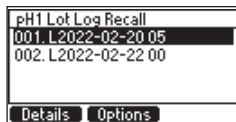

Press **Options** to: Export selected/all log file(s)
Delete all logged files data

To scroll the options, use the keys.



Delete Logged Data

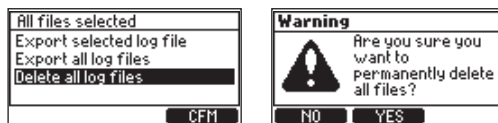

To delete logged files:

- Use the   keys to select the option and press **CFM**. A warning screen is displayed asking for confirmation.
- Press **Yes** to confirm or **No** to return to previous screen.



Note: It is recommended to export log files before deleting the files.

15.2. EVENT LOG & EVENT LOG TYPES

- The log file can hold a maximum of 100 events
 - ▶ errors, alarms, warnings
 - ▶ calibration events
 - ▶ configuration changes
 - ▶ cleaning events
- Once the 100 event limit has been reached, the oldest logged event is deleted.
- Press **1/2** virtual key to enter next screen (i.e. **2/2**) and access diagnosis screen.
- Use the   keys to navigate logged events.
- With USB-C flash drive plugged in, press the corresponding virtual key to export event log file.
- Press **CLR** to erase all event logs.

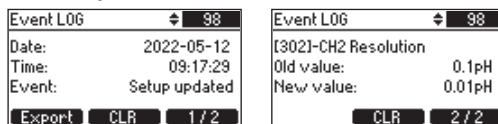

15.2.1. Event types

15.2.1.1. Errors, alarms, warnings

Loss of function

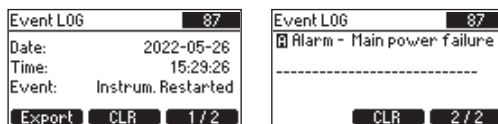

Functional failure

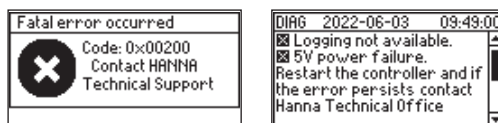

Manufacturing error

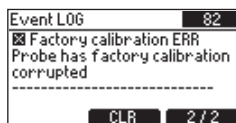
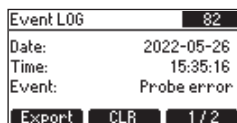

Probe disconnected

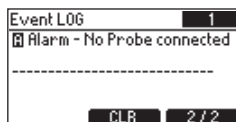
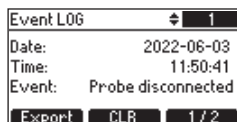

Instrument error

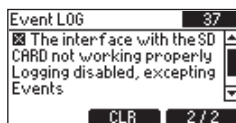
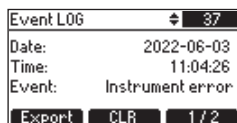

Alarms, Warnings

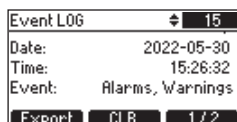

Alarms on measured parameter (outside range limit)

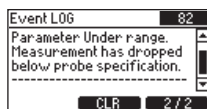
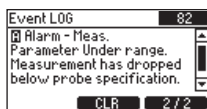
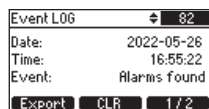
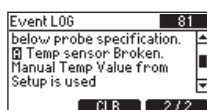
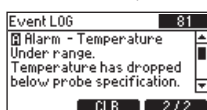
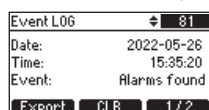

Control Alarm

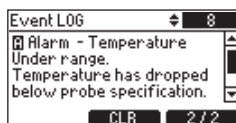
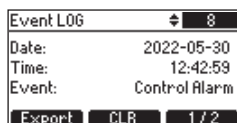

Control Warning

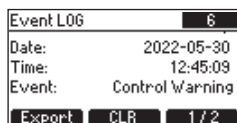

15.2.1.2. Calibration events

User calibration

Event LOG	↕	2
Date:	2022-05-30	
Time:	12:48:15	
Event:	CH2 User calibration	
Export	CLR	1 / 2

Event LOG	↕	2
Date:	2022-05-30	
Time:	12:48:15	
Event:	CH2 User calibration	
Export	CLR	2 / 2

Process calibration

Event LOG	↕	1
Date:	2022-05-30	
Time:	12:48:46	
Event:	CH2 Process cal.	
Export	CLR	1 / 2

Event LOG	↕	1
Date:	2022-05-30	
Time:	12:48:46	
Event:	CH2 Process cal.	
Export	CLR	2 / 2

15.2.1.3. Cleaning events

Cleaning

Event LOG	↕	3
Date:	2022-05-31	
Time:	08:39:04	
Event:	Timered Cleaning	
Export	CLR	1 / 1

Event LOG	↕	1
Date:	2022-05-31	
Time:	08:45:20	
Event:	Cleaning Finished	
Export	CLR	1 / 1

15.2.1.4. Configuration changes

Hold

Event LOG	↕	10
Date:	2022-05-30	
Time:	15:45:22	
Event:	Manual Hold	
Export	CLR	1 / 1

Event LOG	↕	3
Date:	2022-05-30	
Time:	15:49:01	
Event:	Exit Hold	
Export	CLR	1 / 1

Manual Mode

Event LOG	↕	34
Date:	2022-05-30	
Time:	13:26:16	
Event:	Manual Mode	
Export	CLR	1 / 1

Event LOG	↕	33
Date:	2022-05-30	
Time:	13:26:20	
Event:	Exit Manual Mode	
Export	CLR	1 / 1

Firmware update

Event LOG	↕	49
Date:	2022-05-30	
Time:	09:13:51	
Event:	Update firmware	
Export	CLR	1 / 1

Setup update

Event LOG	↕	9 / 1
Date:	2022-05-30	
Time:	15:10:25	
Event:	Setup updated	
Export	CLR	1 / 2

Depending on the number of setup changes, users can access more than one screen by pressing the virtual key for -->.

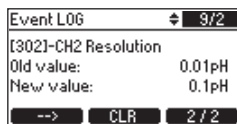
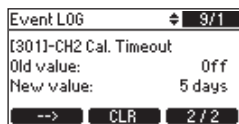

15.2.1.5. Probe specific, HI7640-50 only

ODO Cap Error

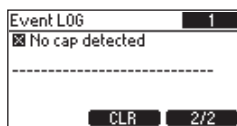
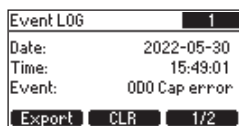

HI520 Log Event Codes & Assigned Parameters

HI520 operates an event logging system whereby when setting new parameter values, a Setup event and event code are generated. Log event stores the Setup event code and both new and previous values.

Code	Setup Parameter	Code	Setup Parameter
0	Key beep	23	CH2 Set point 1 status
1	LCD contrast	24	CH2 Set point 2 status
2	LCD backlight	29	CH1 Set point 1 control mode
3	Time format	30	CH1 Set point 2 control mode
4	Date format	31	CH2 Set point 1 control mode
5	Decimal point	32	CH2 Set point 2 control mode
6	Temperature unit	33	CH1 Set point 1 parameter
8	Log interval	34	CH1 Set point 2 parameter
9	Error beep	35	CH2 Set point 1 parameter
10	Language	36	CH2 Set point 2 parameter
11	Password enable	37	CH1 Set point 1 overtime
12	RS-485 Address	38	CH1 Set point 2 overtime
13	RS-485 Baud rate	39	CH2 Set point 1 overtime
14	Startup control delay	40	CH2 Set point 2 overtime
15	Remote control	41	CH1 Set point 1 minimum on time
16	Controller ID	42	CH1 Set point 2 minimum on time
17	Setup timeout	43	CH2 Set point 1 minimum on time
19	Password setup	44	CH2 Set point 2 minimum on time
20	Password remote	45	CH1 Set point 1 value
21	CH1 Set point 1 status	46	CH1 Set point 2 value
22	CH1 Set point 2 status	47	CH2 Set point 1 value

Code	Setup Parameter
48	CH2 Set point 2 value
49	CH1 Set point 1 control mode
50	CH1 Set point 2 control mode
51	CH2 Set point 1 control mode
52	CH2 Set point 2 control mode
53	CH1 Set point 1, Dead band gain
54	CH1 Set point 2, Dead band gain
55	CH2 Set point 1, Dead band gain
56	CH2 Set point 2, Dead band gain
57	CH1 Set point 1 control period
58	CH1 Set point 2 control period
59	CH2 Set point 1 control period
60	CH2 Set point 2 control period
61	CH1 On/Off, Set point 1 hysteresis Prop. & PID, dead band for Set point 1
62	CH1 On/Off, Set point 2 hysteresis Prop. & PID, dead band for Set point 2
63	CH2 On/Off, Set point 1 hysteresis Prop. & PID, dead band for Set point 1
64	CH2 On/Off, Set point 2 hysteresis Prop. & PID, dead band for Set point 2
65	CH1 Set point 1 deviation
66	CH1 Set point 2 deviation
67	CH2 Set point 1 deviation
68	CH2 Set point 2 deviation
69	CH1 Set point 1, reset time
70	CH1 Set point 2, reset time
71	CH2 Set point 1, reset time
72	CH2 Set point 2, reset time
73	CH1 Set point 1, rate time
74	CH1 Set point 2, rate time
75	CH2 Set point 1, rate time
76	CH2 Set point 2, rate time
77	CH1 Main parameter, Alarm High enable
78	CH1 Temperature parameter, Alarm High enable
79	CH2 Main parameter, Alarm High enable
80	CH2 Temperature parameter, Alarm High enable

Code	Setup Parameter
81	CH1 Main parameter, Alarm Low enable
82	CH1 Temperature parameter, Alarm Low enable
83	CH2 Main parameter, Alarm Low enable
84	CH2 Temperature parameter, Alarm Low enable
85	CH1 Main parameter, Alarm delay off time
86	CH1 Temperature parameter, Alarm delay off time
87	CH2 Main parameter, Alarm delay off time
88	CH2 Temperature parameter, Alarm delay off time
93	CH1 Main parameter, Alarm mask time
94	CH1 Temperature parameter, Alarm mask time
95	CH2 Main parameter, Alarm mask time
96	CH2 Temperature parameter, Alarm mask time
97	CH1 Main parameter, Alarm High value
98	CH1 Temperature parameter, Alarm High value
99	CH2 Main parameter, Alarm High value
100	CH2 Temperature parameter, Alarm High value
101	CH1 Main parameter, Alarm Low value
102	CH1 Temperature parameter, Alarm Low value
103	CH2 Main parameter, Alarm Low value
104	CH2 Temperature parameter, Alarm Low value
116	Cleaning enable
117	Cleaning type
118	Cleaning trigger
119	Cleaning, rinsing post-wash time
120	Cleaning wash time
121	Cleaning, rinsing pre-wash time
122	Cleaning interval
124	Cleaning, wash cycles number
125	Cleaning, rinse-only cycles
131	Cleaning external trigger
133	Cleaning recovery time
135	Cleaning schedule interval, 1 hour
136	Cleaning schedule interval, 2 hours
137	Cleaning schedule interval, 3 hours
138	Cleaning schedule interval, 1 minute
139	Cleaning schedule interval, 2 minutes
140	Cleaning schedule interval, 3 minutes

Code	Setup Parameter
141	Cleaning schedule interval 1, enabled
142	Cleaning schedule interval 2, enabled
143	Cleaning schedule interval 3, enabled
144	Schedule day, Monday
145	Schedule day, Tuesday
146	Schedule day, Wednesday
147	Schedule day, Thursday
148	Schedule day, Friday
149	Schedule day, Saturday
150	Schedule day, Sunday
152	Input 1 function
153	Input 1 active level
154	Input 2 function
155	Input 2 active level
173	Relay 1 function
174	Relay 2 function
175	Relay 3 function
176	Relay 4 function
177	Relay 5 function
178	Hold function enable
179	Hold Input enable
180	Hold Output enable
181	Manual hold
182	Hold Delay
183	Analog out 1, mode
184	Analog out 2, mode
185	Analog out 3, mode
186	Analog out 4, mode
187	Analog out 1, data channel
188	Analog out 2, data channel
189	Analog out 3, data channel
190	Analog out 4, data channel
191	Analog out 1, parameter to follow
192	Analog out 2, parameter to follow
193	Analog out 3, parameter to follow
194	Analog out 4, parameter to follow

Code	Setup Parameter
195	Analog out 1, output range
196	Analog out 2, output range
197	Analog out 3, output range
198	Analog out 4, output range
199	Analog out 1, value for maximum output
200	Analog out 2, value for maximum output
201	Analog out 3, value for maximum output
202	Analog out 4, value for maximum output
203	Analog out 1, value for minimum output
204	Analog out 2, value for minimum output
205	Analog out 3, value for minimum output
206	Analog out 4, value for minimum output
207	Analog out 1, value for Hold is the fixed value
208	Analog out 2, value for Hold is the fixed value
209	Analog out 3, value for Hold is the fixed value
210	Analog out 4, value for Hold is the fixed value
211	Analog out 1, out value when in Hold
212	Analog out 2, out value when in Hold
213	Analog out 3, out value when in Hold
214	Analog out 4, out value when in Hold
215	Analog out 1, out 22 mA on alarm
216	Analog out 2, out 22 mA on alarm
217	Analog out 3, out 22 mA on alarm
218	Analog out 4, out 22 mA on alarm
219	Analog out 1, fixed value selection
220	Analog out 2, fixed value selection
221	Analog out 3, fixed value selection
222	Analog out 4, fixed value selection
224	Serial communication, Baud Rate
225	Serial communication, Parity
226	Serial communication, RemLink_Timeout
227	Serial communication, RemEdit_Timeout
228	Serial communication, Stop Bits
301–311	Probe 1 parameter 1–11 was changed
312–322	Probe 2 parameter 1–11 was changed

To exemplify how the log event system works:

For Setup **event code 21** Set point 1 status; with old value 0 (disabled) and new value 1 (Enabled)

For Setup **event code 22** Set point 2 status; with old value 22 (disabled) and new value 2 (Enabled)

For Setup **event code 34** Set point 2 parameter; with old value 0 main reading (pH or ORP) and new value 1 (Temperature)

For Setup **event code 45** Set point 1 parameter; with old value 8.00 and new value 8.39

Event LOG						
Controller Info		Controller ID	1			
		Serial No.	P0140000111			
		HW Version	R0			
		Firmware	V1.10 X V4.2 2022-06-27			
		Language	2.1			
Decimal separator		X.X				
DATA LOG						
Date	Time	Error	Alarm	Warning	Setup EVT no.	Old value
01.07.2022	14:21:07	---	---	---	[21]-Setpoint1	Disable
01.07.2022	14:21:07	---	---	---	[29]-ModeSetpoint1	ON/OFFHigh
01.07.2022	14:21:07	---	---	---	[45]-ValueSetpoint1	NA
01.07.2022	14:21:07	---	---	---	[61]-HysteresisSetpoint1	NA
01.07.2022	14:21:07	---	---	---	[65]-DeviationSetpoint1	NA
01.07.2022	14:21:07	---	---	---	[173]-Relays1	Disabled

New value	1st point	2nd point	3rd point	Process cal.	Offset	Slope	HOLD	Cleaning
Enable	---	---	---	---	---	---	---	---
PIDHigh	---	---	---	---	---	---	---	---
5.000 g/L	---	---	---	---	---	---	---	---
1.000 g/L	---	---	---	---	---	---	---	---
1.000 g/L	---	---	---	---	---	---	---	---
CtrlSetP1	---	---	---	---	---	---	---	---

Figure 22: Event logging example

16. GENERAL SETTINGS

Navigation

- With item selected, press **Setup** to enter screen.

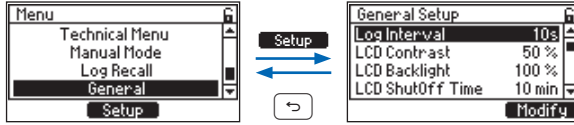

- Use the **▲** **▼** keys to navigate.
- Press the **↶** key to return to the menu without saving.
- At the prompt, enter the passcode.
- At the prompt, select **YES** to place unit in HOLD.
- Press the corresponding virtual key (bottom right hand side of the screen) to confirm selection.

Note: Settings will only be saved by selecting YES in the Menu exit screen warning.

Log Interval

Option: 10 s, 30 s; 1, 2, 5, 10, 15, 30, 60, 120, 180 minutes

- With parameter selected, press **Modify** for the drop-down list to display.
- Use the **▲** **▼** keys to navigate between options.
- Press **Select** to save.

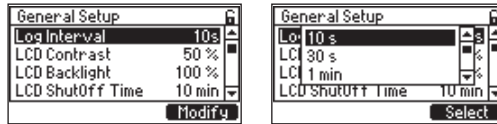

LCD Contrast

Option: 0 to 100 %

- With item selected press **Set** for the horizontal scroll bar that shows the contrast level to display.
- Press the **▲** **▼** keys to increase or decrease the value (keep the key pressed to fast-forward).
- Press **CFM** to save.

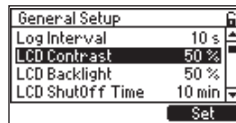

LCD Backlight

Option: 0 to 100 %

- With item selected, press **Set** to open for the horizontal scroll bar that is used to adjust the backlight to display.
- Press the **▲** **▼** keys to increase or decrease the value (keep the key pressed to fast-forward).
- Press **CFM** to save.

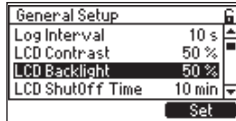

LCD ShutOff Time

Option: 10 min, 30 min, 60 min, Disabled

- With item selected, press **Modify**, for the drop-down list to display.
- Use the **▲** **▼** keys to navigate between options.
- Press **Select** to save.

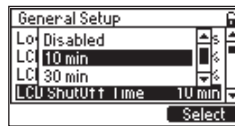
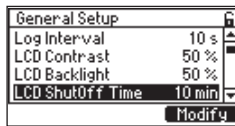

Key Beep

Option: Enabled, Disabled

With item selected, press the corresponding virtual key to toggle between options. An acoustic signal confirms the enabled parameter.

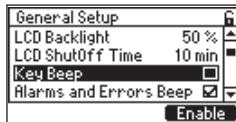

Alarms & Errors Beep

Option: Enabled, Disabled

With item selected, press the corresponding virtual key to toggle between options. The check mark confirms the enabled parameter.

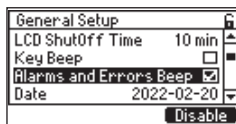

Warning! When enabled, if the measurement is in alarm, a very loud beep will come from controller. Turn on Manual Hold to subdue this Alarm state.

Date

Option: year / month / day

- With item selected, press **Set** to modify.
- With selected value flashing, press the **▶** key to navigate to the right between year / month / day.
- Press the **▲** **▼** keys to increase or decrease the value (keep the key pressed to fast-forward).
- Press **CFM** to save the value.



Date Format

Option: yyyy-mm-dd, dd-mm-yyyy, mm-dd-yyyy, yyyy/mm/dd, dd/mm/yyyy, mm/dd/yyyy

- With item selected, press **Modify** for the drop-down list to display.
- Press the **▲** **▼** keys to navigate between options.
- Press **Select** to save.

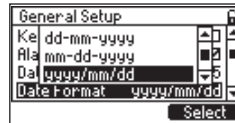
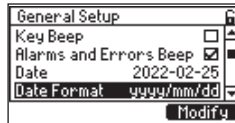

Time

Option: h / m / s

- With item selected, press **Set** to modify.
- Press the **▶** key to navigate right between digits; use the **▲** **▼** keys to increase or decrease the value.
- Press **CFM** to save.

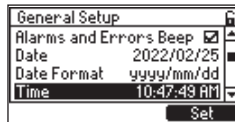

Time Format

Option: hh:mm:ss 24h, hh:mm:ss 12h

- With item selected, press **Modify** for the drop-down list to display.
- Press the **▲** **▼** keys to navigate between options.
- Press **Select** to save.

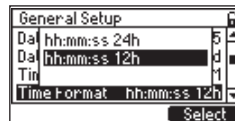
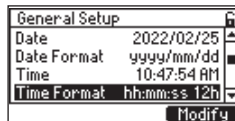

Decimal

Option: "." & ","

This option is a field separator for Log files.

It may be set as comma "," or full stop "." depending upon region preferences.

- With item selected, press the corresponding virtual key to toggle between options.



Temperature Unit

Option: Celsius (°C), Fahrenheit (°F)

With item selected, press the corresponding virtual key to toggle between options.

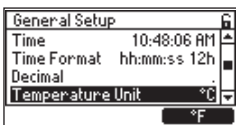

Language

Option: Deutsch, English, Español, Français, Italiano, Magyar, Nederlands, Português

This option allows the user to choose the desired language in which all information will be displayed.

- With item selected, press **Modify**, for the drop-down list to display.
- Press the ▲ ▼ keys to navigate between options.
- Press **Select** to save.

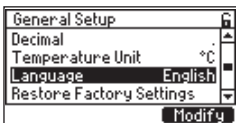

Restore Factory Settings

This option allows the user to erase all user settings and reset the instrument to the default factory settings.

With item selected, press **Set** to restore default settings.

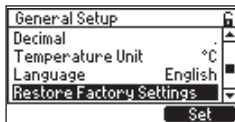

Controller Info

With Controller Info selected, press **View** to display model version, language version, and serial number.

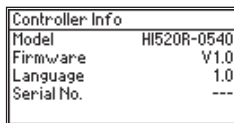

Controller Password

Option: 00000 to 99999

- With item selected, press **Modify** for the password input screen.
- Press the **▲** key to increment the digit (displayed flashing) and the **▼** key to decrement.
- Press **CFM**, to save.
- Press the **▶** key to navigate right between digits.

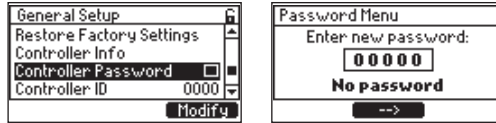

Controller password protects against unauthorized changes. It is required if modifications are made. After the password has been enabled, parameter modifications or probe calibration data are password protected.

- Entering the password unlocks the controller **-->** .
- In measurement mode, the controller is automatically locked again after about 10 seconds **-->** .

For further details, see **Enabling & Disabling the Password** section.

Enabling & Disabling the Password

To enable the password:

1. From Main Menu, press the **▲** or **▼** key to navigate to General setup, Controller password.
2. With Controller Password menu item selected, press **Modify**.



3. Use the **▲** **▼** keys to modify the flashing digit, press the **▶** to move places, repeat. Then press **CFM**, to confirm the choice.

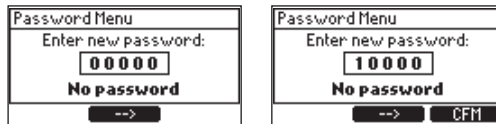

4. Rekey the password and press **CFM** to save the password.

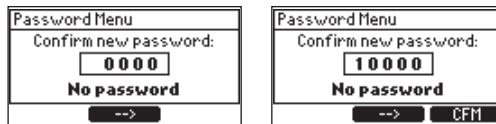

- Once the password has been enabled, the controller displays the confirmation screen and a check mark will appear.



Note: After the password has been enabled, Setup changes are password protected.

Entering the password unlocks the controller  → .

In measure mode, the controller is automatically locked again after about 10 seconds  → .

To disable the password:



- Press **Modify** and use the   keys to enter the password.
- Ignore prompt to enter new password and press **Disable**. The password is automatically disabled.



Note: If the password is entered incorrectly five times, users will require assistance from Hanna Instruments service team.

Controller ID

Option: 0000 to 9999

- With Controller ID selected, press **Set** to modify.
- Press the   keys to increase or decrease the value (keep the key pressed to fast-forward).
- Press **CFM**, to save.



Note: If you have more than one Controller it is advisable to give each a separate Controller ID.

Remote Control

Option: Enabled, Disabled

This option allows the user to enable Remote Control. This must be enabled if using the Modbus protocol.

With item selected, press the corresponding virtual key, to toggle between options. The check mark confirms the enabled parameter.



Comm Protocol (Communication Protocol)

Option: Modbus RTU

Read-only parameter that indicates supported remote communication mode. With protocol selected, press **Setup** to start configuring.



Configurable Communication Protocol Parameters

Net Address

Option: 01 to 99

This option allows the user to set the controller’s Modbus address.

- With item selected press **Set** to modify.
- Press the **▲** **▼** keys to increase or decrease the value (keep the key pressed to fast-forward).
- Press **CFM** to save.

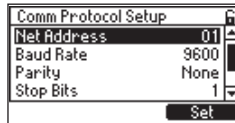

Baud Rate

Option: 9600, 19200, 38400, 57600, 115200, 256000

This option allows the user to set the desired speed for the serial communication (baud rate) in bps.

Note: The controller and the Modbus server must have the same baud rate.

- With item selected, press **Modify** for the drop-down list to display.
- Use the **▲** **▼** keys to navigate between options.
- Press **Select** to save.

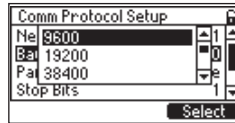
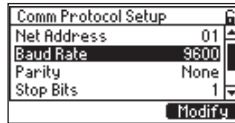

Parity

Option: None, Odd, Even

This option allows the user to set communication parity based on the parity mode of the connected device.

- With Parity selected, press **Modify** for the drop-down list to display.
- Press the **▲** **▼** keys to navigate between options.
- Press **Select** to save.

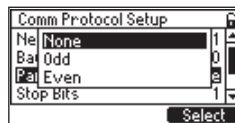
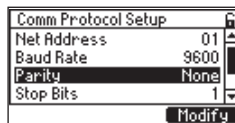

Stop Bits

Option: 1, 2

This option allows the user to set stop bit option based on the stop bit of the connected device.

- With Stop Bits selected, press **Modify** for the drop-down list to display.
- Use the **▲** **▼** keys to navigate between options.
- Press **Select** to save.

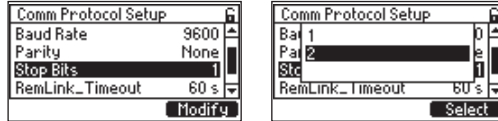

RemLink_Timeout

Option: 10 to 1200 s

This option allows the user to enter the number of seconds that a remotely connected device should wait for an acknowledgement (for a command) before timing out.

- With item selected, press **Set** to modify.
- Press the **▲** **▼** keys to increase or decrease the value (keep the key pressed to fast-forward).
- Press **CFM** to save.

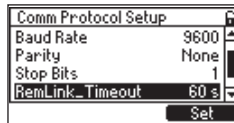

RemEdit_Timeout

Option: 10 to 1200 s

This option allows the user to enter the number of seconds that a remotely connected device should wait before exiting Edit mode.

- With item selected, press **Set** to modify.
- Press the **▲** **▼** keys to increase or decrease the value (keep the key pressed to fast-forward).
- Press **CFM** to save.

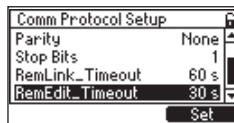

Startup Delay

Option: 1 to 30 minutes

Startup Delay is a timer used to prevent Control functions (relays or outputs configured for measurement or temperature) from functioning during controller startup.

- With item selected, press **Set** to modify the time.
- Press the **▲** **▼** keys to increase or decrease the value (keep the key pressed to fast-forward).
- Press **CFM** to save.

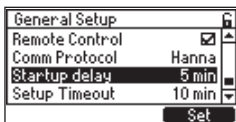

During power up the following will be displayed as the counter counts down in 10 seconds intervals.

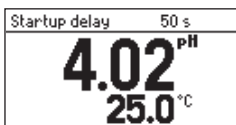

Setup Timeout

Option: 1 to 30 minutes

Setup Timeout is a timer used to bring the controller back to Measure mode from another mode when no keyboard input has occurred. Selected changes will not be saved.

- With Setup Timer selected, press **Set** to modify.
- Press the **▲** **▼** keys to increase or decrease the value (keep the key pressed to fast-forward).
- Press **CFM** to save.

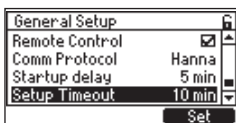







Setup Note: The controller validates the configured Setup when attempting to exit Menu and directs the user to any invalid parameters. At prompt, to save changes, press **YES** to confirm choice.

Default values

Controller setting	Probe type				Temperature
	pH	ORP	DO	EC	
Alarm High	Probe maximum range				
Alarm Low	Probe minimum range				
Set point	8.00 pH	500 mV	DO_Conc: 8.26 mg/L DO_Sat: 100 %	sal %: 200 % EC: 10.00 mS/cm	25 °C (77 °F)
Hysteresis for ON/OFF Control	1.00 pH	50 mV	5.0 %Sat	1.000 mS	3.0 °C (37 °F)
Deviation for Proportional Control	1.00 pH	50 mV	5.0 %Sat	2.000 mS	3.0 °C (37 °F)
Analog output Parameter	Ctrl. Setpoint 1				
Analog output 0 mA limit	– 100 %				
Analog output 20 mA limit	200 %				
Fixed value for AO Hold mode	50 %	50 %	50 %	50 %	25 °C (77 °F)

Operational overview mode

LED status legend

STATUS	HOLD
 Measure mode	
 Warning	 HOLD Off
 Errors	 HOLD On
 Alarms	

18. CONTROL MODES & ALGORITHMS

HI520 is intended to be used to control industrial processes. The **instrument** and **sensor** measure the **process variable**. **HI520** uses **control settings** to control **outputs** that are connected to **auxiliary equipment** to control the process variable to the desired value.

The **HI520** uses smart probes to measure the process variable and temperature. The smart probe stores the probe type, calibration data, Model, Firmware version, Serial number and Factory calibration date in the probe. In the case of a pH probe, it converts the high impedance mV value to a digital signal for clean measurement transport to the controller.

The controlled variable can be selected between supported parameter (parameter probe) and temperature. Once selected, any alarm conditions link to it alone.

There are three types of algorithm corrections that can be applied to the control function: On/Off, Time proportional, and Proportional Integral & Derivative (PID).

The **HI520** uses outputs to interact with pumps, valves, and other equipment to control a process. It contains Relays and Analog Outputs for this purpose.

Control Output Element	Output
Relays	On or Off
Analog Outputs (AO)	0-20 or 4-20 mA

The **On relay state** occurs when the relay is energized:

- ▶ NO and COM connected
- ▶ NC and COM disconnected

The **Off relay state** occurs when the relay is de-energized:

- ▶ NO and COM disconnected
- ▶ NC and COM connected

The Analog outputs can be adjusted to a minimum value of 0 mA (default) or 4 mA and a maximum value of 20 mA. See **10.2 Analog Outputs**

Control Algorithms



This section describes the controller behavior with a pH smart probe. It presents a similar behavior with other smart probes.

There are three control algorithms implemented in **HI520**; and each algorithm has both specific and common settings. The common settings — overtime & minimum on time — affect control output after the specific algorithm settings and rules are evaluated.

The **overtime** (safety timer) sets the maximum continuous time that the control element is running at it's maximum value. If this time is exceeded, the control will be stopped and an alarm generated.

The **minimum on time** timer sets a time value to control the speed of the relay status change. This timer prevents the relay and connected device from “chattering” by forcing a minimum on and off time. This is necessary to protect elements that are driven (e.g. actuators, motors, contactors) from electrical and mechanical shocks.

Navigation:

- Press the  from the Measure mode.
- Select **Setup** from Channel.
- Select **Setup** with Control Settings highlighted.
- Press the   keys to move between parameters.
- Select parameter to be controlled.
- Assign the Set point value and select control mode: On/Off (constant), Proportional, PID.

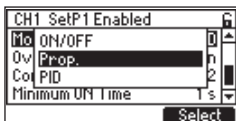

18.2.1. On/Off Control Algorithm

On/Off Control is the simplest type of feedback control. The controller drives the relay On or Off, and the Analog Output at the maximum or at the minimum value depending on the position of the controlled variable relative to the Set point. The control mode can be set **High** or **Low**. **High control** mode is recommended if the process value is too high and users want to decrease it using an acid. **Low control** mode is recommended if the process value is too low and users want to increase it using a base.

Inputs

- Set point as an absolute controlled parameter value
- Control mode as High or Low
- Hysteresis as a relative parameter, one-side only

Outputs

- Control output as either 0 or 100 %

Update rate = 1 second

Enabled by

- Settings
- Controller status

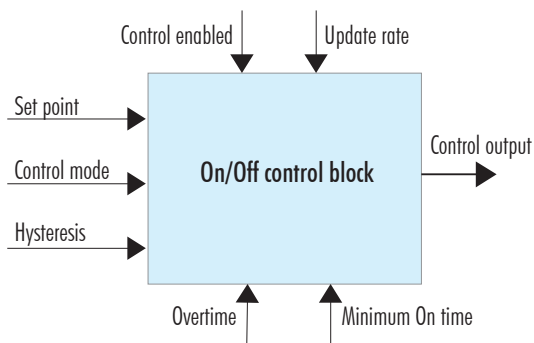

Figure 23: On/Off Control Block Algorithm

On/Off control (Low mode) is modeled as follows:

$$CO_{n-1} = 1$$

$$CO_n = \begin{cases} 1 & \text{if } PV \leq SP + Hysteresis \\ 0 & \text{if } PV > SP + Hysteresis \end{cases}$$

$$CO_{n-1} = 0$$

$$CO_n = \begin{cases} 1 & \text{if } PV < SP \\ 0 & \text{if } PV \geq SP \end{cases}$$

CO — Control Out
PV — Process Value
SP — Set point

On/Off control of a batch pH process using a pump as external dosing device

Dosing solution can be an acid or a base, depending on the desired results. Control mode can be set as High or Low. With On/Off control type enabled in Setup, the algorithm uses configured "Set point" and "hysteresis" parameters. See 6.3 (Process) Control Settings & Alarm Settings section for further details.

With High mode control, the hysteresis is below the Set point. With Low mode control, the hysteresis is above the Set point.

- When in High control mode the controlled process value is too high. The dosing pump runs (adding an acid to bring down the pH) until the process value decreases to the Set point minus hysteresis value. Above the Set point, the relay is activated. The dosing pump turns off and remains off until process value reaches Set point value.
- When in Low control mode, the controlled process value is too low. The dosing pump starts running (adding a base to bring up the pH) until it reaches the Set point plus hysteresis. The pump remains off until the process value decreases to a value equal to Set point.

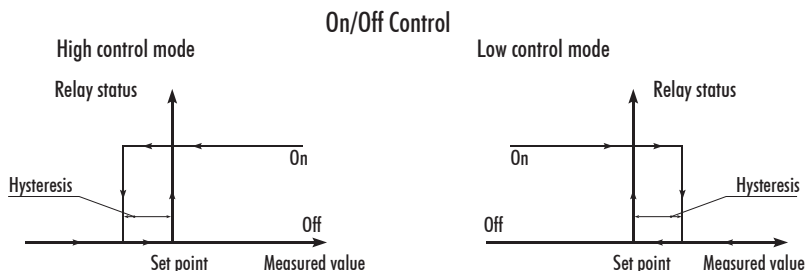

Figure 24: On/Off Control, High /Low Control Mode

Following graphs exemplify how the input parameters work.

Here's an example of hysteresis-free control output.

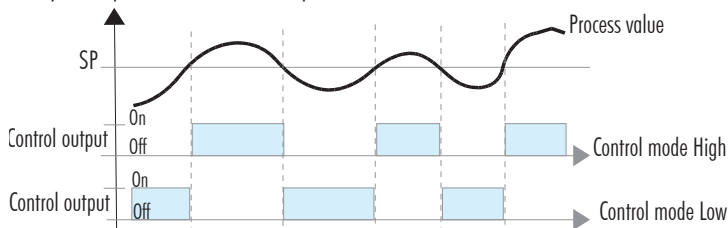

Figure 25: General On/Off Control

By setting hysteresis, an upper and lower control limit is created. The switching around the Set point is thus reduced.

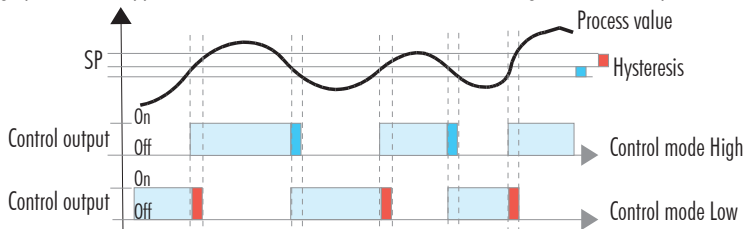

Figure 26: On/Off Control with Hysteresis

Running control On continuously for an extended period of time is prevented by Overtime control action.

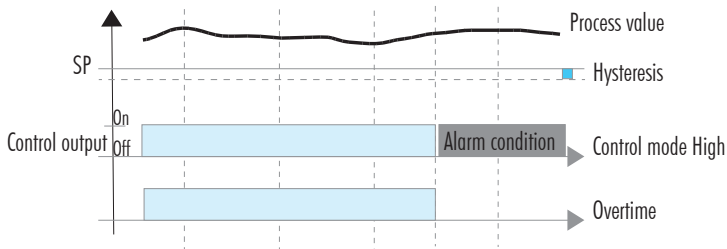

Figure 27: On/Off Control, Overtime Control Action

Relay On time has a guaranteed minimum to prevent stressing the actuators electrically or mechanically.

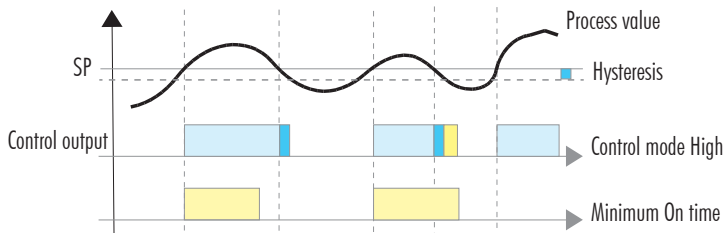

Figure 28: On/Off Control, Minimum On Time

On/Off Control Interaction with Controller Status

Function / Mode		Control Output	Relay assigned to Setpoint Control Output	Analog Output assigned to Setpoint Control Output
Control	Measure	0 or 100 %	Off or On	Scaled value of control output
	Start up	0 %	Off	Scaled value of control output
	Hold	0 %	Off	Scaled value of last control output or a fixed value of control output
	Alarm*	0 %	Off	Scaled value of control output or 22 mA, if option configured
Cleaning		0 %	Off	Scaled value of last control output or a fixed value of control output
Edit		0 %	Off	Scaled value of last control output or a fixed value of control output
Calibration		0 %	Off	Scaled value of control output or a fixed value of control output
Manual		0 %	On or Off	Any value in range 0 to 22 mA
Error		0 %	Off	Scaled value of control output

* Controlled parameter alarms, overtime control alarms, probe disconnected

18.2.2. Proportional Control Algorithm

With proportional Control (Proportion) the controller drives the relay from continuous On to Off in a defined control period. The Relay On time of the activated control is proportional to the “deviation value”, a variance from the Set point. At the full deviation the relay is fully On with the maximum output occurring. As the measurement approaches the Set point through the deviation, the On time (relay energized) is decreased. This provides tighter control of a process variable compared to On / Off control.

It is best used in batch or recirculating systems that retain the solution for a period of time.

Inputs

- Set point as an absolute controlled parameter value
- Control mode as High or Low
- Deviation as a relative parameter
- Control period as time
- Dead Band as a relative parameter value

Where:

Deviation is the interval aligned with the Set point where control output can take values from 0 to 100 %. 0 % indicates no action and 100 % indicates full control output action. If control output is assigned to a relay, 0 % control output will keep relay Off during control time, while 100 % will drive relay On for this entire time. A low value for this parameter is suitable for low latency processes, allowing the control system to react quickly and strongly.

Control Period is the time interval required for updating control output. High dynamic processes require frequent control updates, meaning shorter control periods.

Dead Band represents an area where the error between Set point and process value is considered 0. Dead Band area is unidirectional, for Control mode Low is below the Set point, for control mode High is above the Set point.

Outputs

- Control output as 0 to 100 %

Update rate = Control period

Enabled by

- Settings
- Controller status

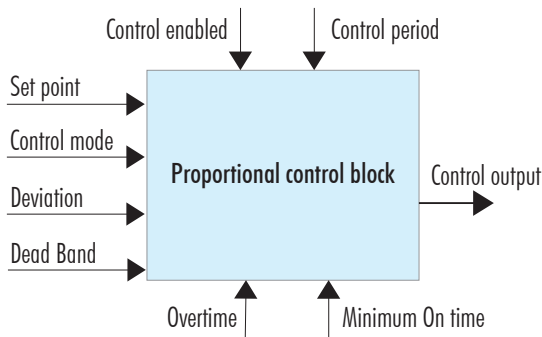

Figure 29: Proportional Control Block

The Proportional Control (Low mode) is modeled as follows:

$$CO_{n-1} > 0$$

$$error = SP - PV$$

$$error \begin{cases} 0 & \text{if } SP - PV < 0 \\ DEV & \text{if } SP - PV \geq DEV \end{cases}$$

$$CO_n = \frac{error}{DEV}$$

$$t_{on} = CP \cdot CO_n$$

$$t_{off} = CP - t_{on}$$

$$CO_{n-1} = 0$$

$$error = SP - PV$$

$$error \begin{cases} 0 & \text{if } SP - PV < DB \\ DEV & \text{if } SP - PV > DEV \end{cases}$$

$$CO_n = \frac{error}{DEV}$$

$$t_{on} = CP \cdot CO_n$$

$$t_{off} = CP - t_{on}$$

CO – Control Out	CP – Control Period
PV – Process Value	t _{0n} – Time Relay is On over CP
SP – Set point	t _{0ff} – Time Relay is Off over CP
DB – Dead Band	t _{n-1} – Time at n-1 CP
DEV – Deviation	t _n – Time at n CP
error = SP - PV	

Proportional control of a batch pH process using a pump as external dosing device

Same as with On/Off control, for Proportional control, a dosing solution can be an acid or a base depending on the desired results. Control mode can be set High or Low.

With Proportional control enabled in Setup, the dosing time depends on the Deviation, the Control period, and how far the measurement is from the Set point. The controller will vary the On and Off times in the defined control period.

Once enabled, and within the Deviation, the duration of the activated control is proportional to the variance; as the measurement approaches set point, the On period (relay energized) diminishes.

Note: When configuring the Setup values for this control type, it is important to understand the dynamics of the process. This can be determined by manually adding chemicals to the process and seeing how long they take to react. The control period should be approximately 1½ times it takes the system to react. If this time is too short an additional dose causes overshooting the desired Set point, if it is too long, the Set point may never be reached.

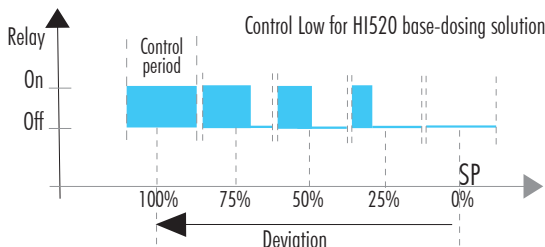

Figure 30: Control Low with Relay On, Set Point and Deviation

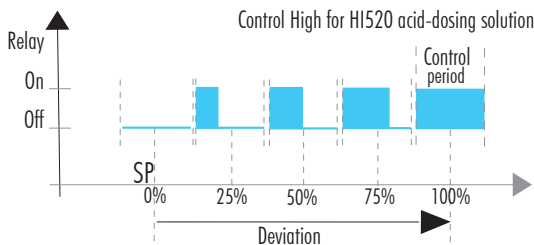

Figure 31: Control High with Relay On, Set Point and Deviation

Following graphs exemplify how the input parameters work. Relay On time is proportional with Setpoint variance over Control period.

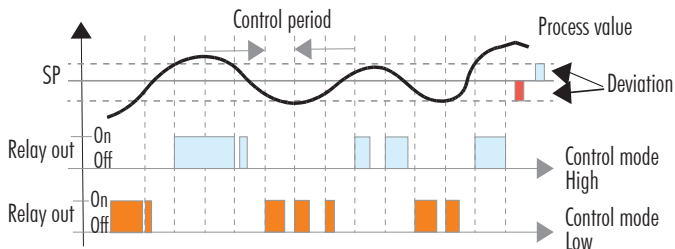

Figure 32: Proportional Control, Relay Out - Control Mode High/Low

Analog Output is proportional with Set point variance over Control period.

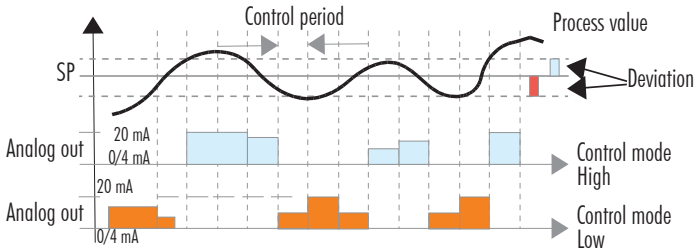

Figure 33: Proportional Control, Analog Out - Control Mode High and Low

Running control On continuously for an extended period of time is prevented by Overtime control action.

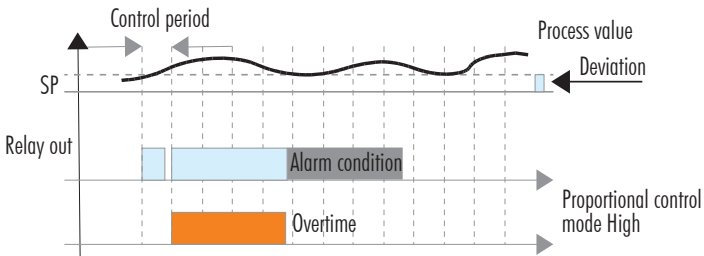

Figure 34: Proportional Control, Relay Out - Proportional Control Mode High, Overtime

Relay On time has a guaranteed minimum to prevent stressing the actuators electrically or mechanically.

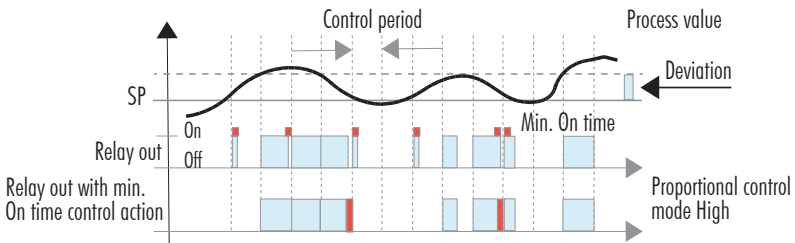

Figure 35: Proportional Control, Relay Out, Proportional Control Mode High, Min. On Time

Dead band minimizes noise influence on control output near Set point.

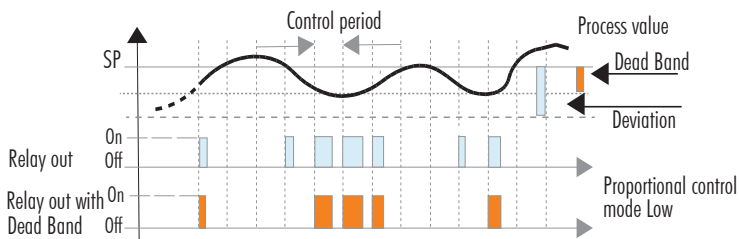

Figure 36: Proportional Control, Relay Out, Proportional Control Mode Low with Dead Band

Proportional Control Interaction with Controller Status

Function / Mode		Control Output	Relay Assigned to Set Point Control Output	Analog Output Assigned to Set Point Control Output
Hold	Measure	0 to 100 % "On" from Control Period	"On" for the time control output is On	Scaled value of control output
	Start up	0 %	Off	Scaled value of control output
	Hold	0 %	Off	Scaled value of last control output or a fixed value of control output
	Alarm*	0 %	Off	Scaled value of control output or 22 mA, if option configured
Cleaning		0 %	Off	Scaled value of last control output or a fixed value of control output
Edit		0 %	Off	Scaled value of last control output or a fixed value of control output
Calibration		0 %	Off	Scaled value of last control output or a fixed value of control output
Manual		0 %	On or Off	Any value in range 0 to 22 mA
Error		0 %	Off	Scaled value of control output

* Controlled parameter alarms, overtime control alarms, probe disconnected

18.2.3. Proportional Integral Derivative (PID) Control Algorithm

PID control on the [HI520](#) is a mathematical control-loop method that automatically applies algorithm corrections to the control function.

Proportional, Integral, and Derivative control actions are brought together to create a single PID control algorithm. PID systems use feedback (through integration) and prediction (through differentiation) algorithms.

Various tuning parameters must be set by the user and these enable a prediction based on the speed of the process response to the output. With a well-tuned system, overshoot, offset and oscillations are eliminated.

PID can be used for closed loop (e.g. batch tank) and open loop (e.g. chemical injection into a pipe) systems.

Inputs

- Set point as the desired value of the controlled parameter
- Control mode as High or Low
- Deviation as a relative parameter
- Control period as time
- Reset time for integrative component as time
- Rate time for derivative component as time
- Dead Band as a relative parameter
- Dead Band Gain as 0 to 100 %

Where:

Deviation is the interval aligned with the Set point where control output proportional term can take values from 0 to 100 %. 0 % indicates no action and 100 % indicates full control output action. If control output is assigned to a relay, 0 % control output will keep relay Off during control time, while 100 % will drive relay On for this entire time. A low value for this parameter is suitable for low latency processes, allowing the control system to react quickly and strongly.

Control Period is the time interval required for updating PID control output. High-dynamic processes require frequent PID calculations updates, meaning shorter Control periods.

Reset time indicates the history of the process control efficiency - sum of errors between Set point and measured process value. A low value for this parameter, will increase the representation of previous errors in the control output. This option is appropriate if deviation parameter is large or/and process has a high latency.

Rate time is a predictive parameter that indicates the speed of evolution of the control errors. It is based on current and previous errors. A large value will increase control response to fast disturbances, but will also make control more vulnerable to noise. Slow processes require rate time to be close to 0.

Dead Band represents an area where the error between Set point and process value is considered 0. The integrative term does not change in this area.

Dead Band Gain is a coefficient applied to PID integrative term in the Dead Band area. 0 % indicates that the integrative term is nullified and 100 % indicates that the term is part of the control output.

Outputs

- Control output as 0 to 100 %

Update rate "-" = Control period

Enabled by

- Settings
- Controller status

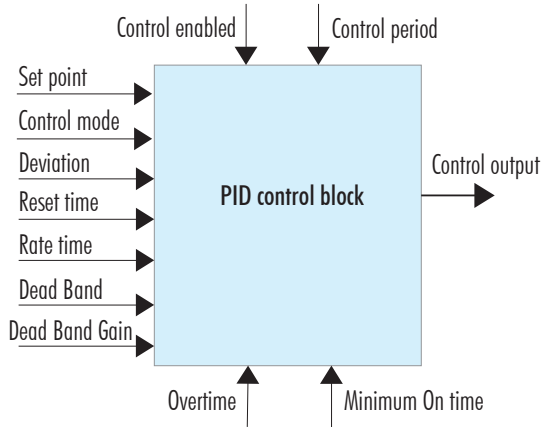

Figure 37: PID Control Block

The transfer function of a PID Control is modeled as follows:

$$K_p + K_i/s + s K_d = K_p (1 + 1/(s T_i) + s T_d)$$

with:

$$T_i = K_p/K_i, T_d = K_d/K_p$$

where:

- ▶ the first term is the Proportional action
- ▶ the second term is the Integrative action
- ▶ the third term is the Derivative action

Proportional action can be set by means of the Proportional Band (PB). PB is expressed in percentage of the input range and is related to K_p with:

$$K_p = 100/PB$$

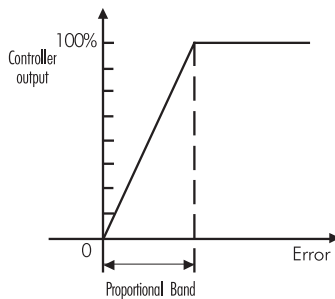

Figure 38: Proportional Action by Means of Proportional Band

The proportional action is set directly as Deviation (D) in control parameter units.

The relation between D and PB is:

$$D = \text{Range} * \text{PB}/100$$

$$T_i = K_p/K_i, \text{ Reset time}$$

$$T_d = K_d/K_p, \text{ Rate time}$$

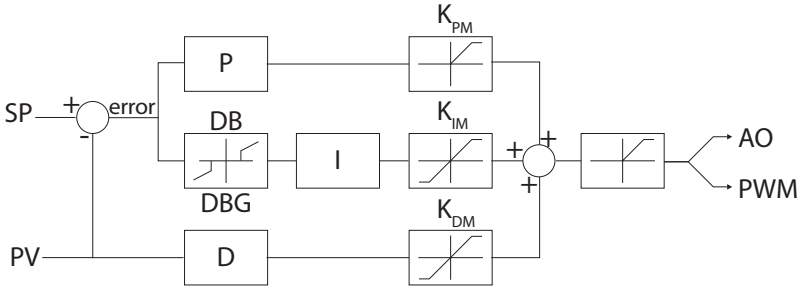

Figure 39: Controller Structure Representation

SP – Set Point	DBG – Dead Band Gain
PV – Process Value	K_{PM} – Maximum proportional term representation
P – PID proportional term	K_{IM} – Maximum integrative term representation
I – PID integrative term	K_{DM} – Maximum derivative term representation
D – PID derivative term	AO – Analog Out
DB – Dead Band	PWM – Output driving relays

PID control of a batch pH process using a pump as external dosing device

As with On/Off and Proportional control, a dosing solution can be an acid or base depending on the desired results; and the control mode can be set High or Low.

With PID control enabled in Setup, the dosing time depends on the Deviation, Control period, Reset time, Rate time, as well as how far the measurement is from the Set point.

Once enabled, a controller in proportional/integral mode (PI mode) works in a fashion similar to a controller in proportional mode, but also integrates the error over time to reduce the variance error to zero.

A controller in PID mode incorporates the three control functions into a single control scheme. The addition of derivative function to the PI mode results in the capacity to attenuate overshoots to some extent, but adds the risk of instability if the process is noisy.

Proportional Function

With the proportional function, control output is proportional to the variance value.

Figure 40 illustrates the process controller behavior with a pH probe. Similar graph may apply for mV measurements.

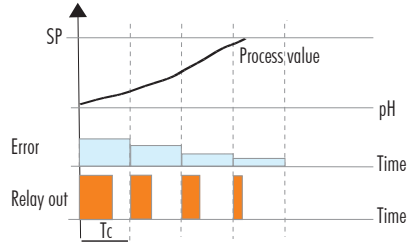

Figure 40: Proportional Function with pH Probe Connected

When a relay is assigned to proportional control, the controller calculates the relay activation time at certain moments e.g. t_0 , $t_0 + T_c$, $t_0 + 2T_c$ ($T_c = \text{Control period}$).

The On interval (shaded areas) is dependent on the error value.

Integral Function

With the integral function (**Reset time**), the controller will reach a more stable output around the Set point, providing a more accurate control than with the On/Off or proportional action only. The integral function uses feedback.

Derivative Function

The derivative function (**Rate time**) compensates for rapid changes in the system reducing undershoot and overshoot of the pH value. The derivative function utilizes predictive behavior.

During PID control, the On interval is dependent not only on the variance value but on previous measurements too.

Figure 41 illustrates how the response overshoot can be improved with a proper Rate-time setting.

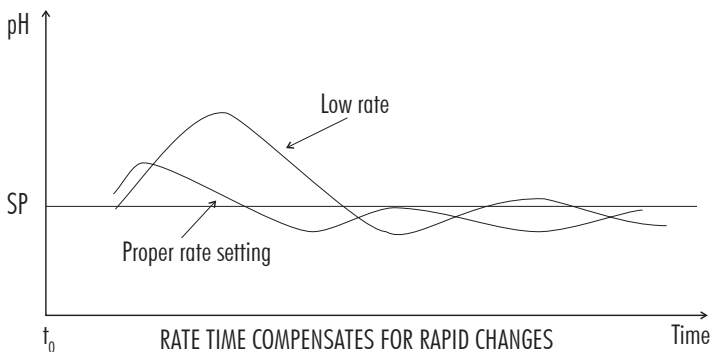

Figure 41: Derivative Function with pH Probe Connected

Tuning PID Parameters using relay on/off controlled device

PID parameters have to be adjusted to a user's process variables. Values for PID parameters depend on the installing process characteristics e.g. overall liquid volume, recirculated flow, dosed reagent concentration, flow mixing, process buffering, electrode's response time.

Optimum values for PID parameters can be tuned (adjusted) after an experimental tuning procedure. To get the best possible control, a "trial and error" tuning procedure must be first performed.

Below listed five parameters can be adjusted to achieve a fast response time and a small overshoot:

- ▶ Set point
- ▶ Deviation
- ▶ Reset time
- ▶ Rate time
- ▶ Control period

Note: Users have to disable the derivative and integrative actions by setting the Rate time to 0 and Reset time to maximum. Control period and Set point need to be at maximum value. Deviation needs to be set at minimum value.

Please note that this procedure allows for a rough setting of the PID parameters only and would not fit all processes. Reset time and Rate time parameters should be set by technical personnel only.

1. Turn On controller. Set the log interval to 10 s.
2. Start with a solution that has a pH or mV value different enough from the dosed liquid (e.g. a minimum of 3 pH or 150 mV difference).
3. Turn On the dosing device at its maximum capacity and note down the starting time to correlate with controller real time clock taken from the daily log files.
4. The pH or mV will start to vary and subsequently will reach a maximum rate of change (slope).
5. At this stage, stop dosing reagent.
6. Transfer the log file on a USB flash drive.
7. Connect to a PC and download the data from the USB flash drive and prepare the process graphic.
8. On the chart draw a tangent to the maximum slope point until it intersects with the horizontal line corresponding to the initial pH or mV value. Read the system time delay (T_x) on the time axis.
9. The deviation, Reset Time and Rate Time can be calculated from the following:
 - Deviation = $T_x \cdot \text{max. slope (pH or mV)}$
 - Reset time = $T_x / 0.4$ (minutes)
 - Rate time = $T_x \cdot 0.4$ (minutes)
10. Set the above parameters and restart the system. If the response has too much overshoot or is oscillating, the system can be fine-tuned by slightly increasing or decreasing the PID parameters one at a time.

The example graph given here was obtained by dosing an alkaline solution to a weak acid solution in a tank. For this, the initial settings have been:

- Maximum slope = $3 \text{ pH}/5 \text{ minutes} = 0.6 \text{ pH/minute}$
- Control period = $T_x = \text{approx. } 7 \text{ minutes}$
- Deviation = $T_x * 0.6 = 4.2 \text{ pH}$
- Reset time = $T_x / 0.4 = 17.5 \text{ minutes}$
- Rate time = $T_x * 0.4 = 2.8 \text{ minutes}$

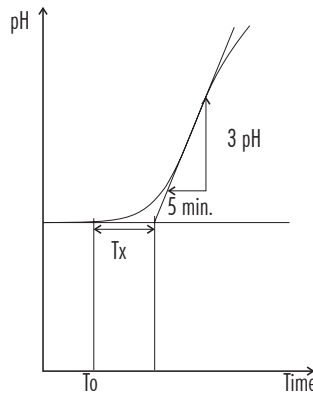

Figure 42: Tunning PID Parameters, Dosing an Alkaline Solution to a Weak Acid

PID Control

Following graphs exemplify how input parameters work.

Control is proportional with the Set point variance, the sum of previous control errors and an estimation of the future ones.

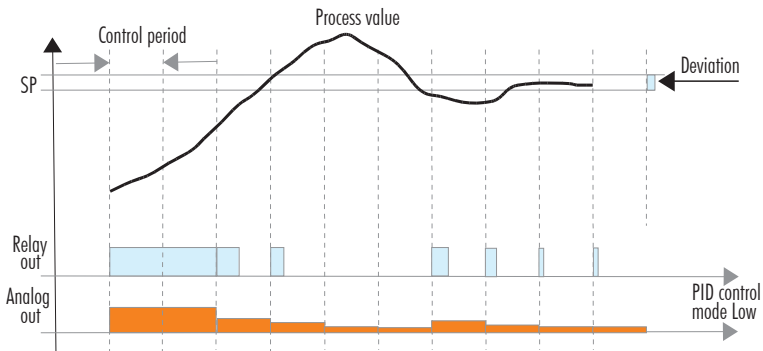

Figure 43: PID Control Mode Low, Relay & Analog Out

Relay On time has a guaranteed minimum to prevent stressing the actuators electrically or mechanically.

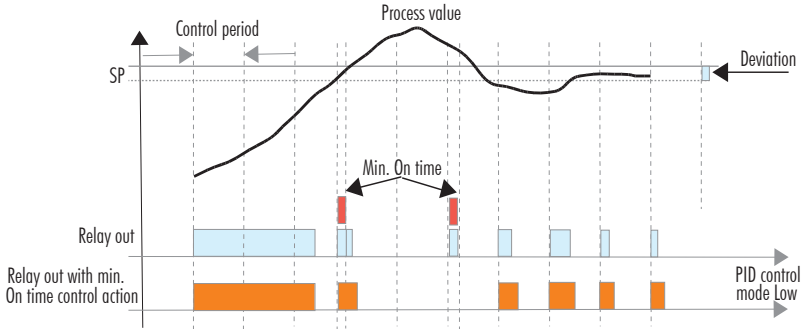

Figure 44: PID Control Mode Low, Relay Out with Minimum On Time

To minimize overshooting, the integrative control part is zeroed as it approaches Set point.

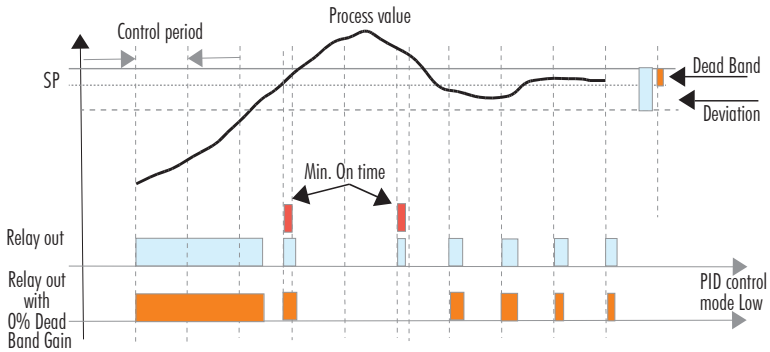

Figure 45: PID Control Mode Low, Relay Out with 0% Dead Band Gain

To minimize overshooting, the integrative control part is diminished as it approaches Set point.

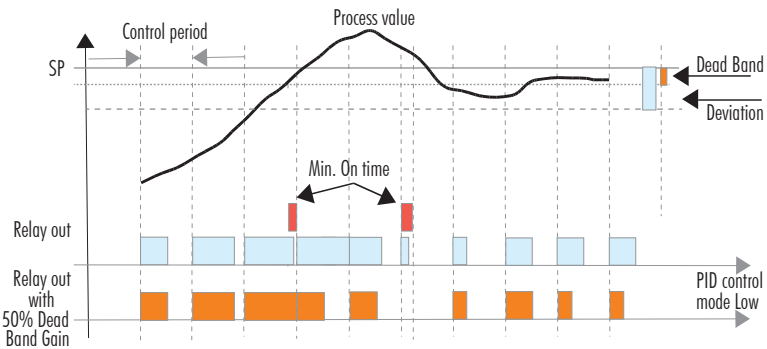

Figure 46: PID Control Mode Low, Relay Out with 50% Dead Band Gain

PID Control Interaction with Controller Status

Function / Mode		Control Output	PID Calculations	Relay Assigned to Set Point Control Output	Analog Output Assigned to Set Point Control Output
Hold	Measure	0 or 100% "On" from Control Period	On	"On" for time control output is On	Scaled value of control output in mA
	Start up	0 %	Freeze	Off	Scaled value of control output
	Hold	0 %	Reset to 0 and freeze	Off	Scaled value of last control output or a fixed value of control output
	Alarm	0 %	Reset to 0 and freeze	Off	Scaled value of last control output or 22 mA, if option configured
Cleaning		0 %	Freeze	Off	Scaled value of last control output or a fixed value of control output
Edit		0 %	Reset to 0 and freeze	Off	Scaled value of last control output or a fixed value of control output
Calibration		0 %	Reset to 0 and freeze	Off	Scaled value of last control output or a fixed value of control output
Manual		0 %	Reset to 0 and freeze	On or Off	Any value in 0 to 22 mA range
Error		0 %	Reset to 0 and freeze	Off	Scaled value of control output

19. CLEANING MODE

Data acquisition is done by digital probes via specific sensors.

Due to process conditions sensors can get clogged. To maintain accurate and reliable data, the HI520 has implemented the cleaning control function as a basic feature.

When in cleaning mode, the controller activates an external device (e.g. a pumps or valves).

Cleaning control block provides a specific sequence on cleaning outputs based on two control algorithms: **Simple cleaning** and **Advanced cleaning**.

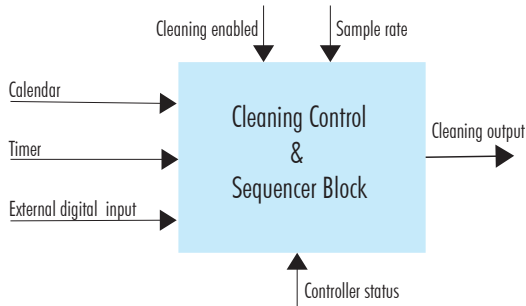

Figure 47: Cleaning Control & Sequencer Block

19.1. OVERVIEW OF CLEANING TYPES

Cleaning	Triggers	Associated Relay	Steps
Simple water only	<ul style="list-style-type: none"> internal triggers (timer¹, schedule²) external trigger manual start 	any non-assigned relay can be set as Rinse Relay	<ul style="list-style-type: none"> instrument enters HOLD mode configured relay(s) is (are) energized
Advanced water detergent	<ul style="list-style-type: none"> internal triggers (timer¹, schedule²) external trigger manual start 	any non-assigned relay can be set for advanced cleaning (i.e. at least one Rinse Relay and Wash Relay)	<ul style="list-style-type: none"> instrument enters HOLD mode rinse is energized (pre-rinsing phase) wash is energized (detergent phase) wash is de-energized (post-rinsing phase)

¹ If the trigger is set to timer, entering in a Hold mode that overlaps with the trigger will add a delay to the cleaning cycle.

² If the trigger is set to schedule, entering in a Hold mode that overlaps with the trigger of the next start time and exceeds the set time, the trigger will be lost. The trigger will still be activated if the internal clock doesn't get past a minute over start time.

19.2. CLEANING BLOCK INPUTS & OUTPUTS

Cleaning block inputs and outputs are common to both Simple and Advanced cleaning.

Inputs common to both types:

- Calendar
 - ▶ cleaning triggered at specific time and week day. Internal RTC will be used as reference
- Timer
 - ▶ cleaning triggered at a fix interval. The one second time base interval will be used for that.
- External digital inputs
 - ▶ cleaning triggered at transition from inactive to active state on one or more digital inputs, provided the inputs are assigned to do this
- Controller status
 - ▶ cleaning can be stopped, suspended, or resumed upon controller reaching certain status
- Cleaning enabled
 - ▶ main condition that allows (or not) cleaning to run
- Sample rate
 - ▶ timing has the one second time-base interval used for all time-sequences evaluation

Outputs are assigned as:

- **Rinse** for both Simple and Advanced cleaning where one or more relays are assigned to cleaning, **rinse phase**.
- **Wash** for Advanced cleaning where one or more relays are assigned to cleaning, **wash phase**.

19.3. CLEANING SEQUENCES

Cleaning sequences are specific to each cleaning type and are defined as follows:

Simple cleaning

- Rinse time, the time that Rinse relay is activated
- Recovery time, the time necessary for the probe sensors to reach stable and accurate measurements

Advanced cleaning

- Pre-Wash rinse time — allocated to sensor rinse before washing
- Wash time — allocated to sensor wash with a washing solution
- Post-Wash rinse time — allocated to sensor rinse after washing
- Wash cycles number — cycles completed (rinsing and washing solutions)
- Rinse-Only cycles number — cycles completed (rinsing only solutions)
- Recovery time — necessary for probe sensors to reach stable and accurate measurements

19.4. CLEANING ALGORITHMS

Simple Cleaning

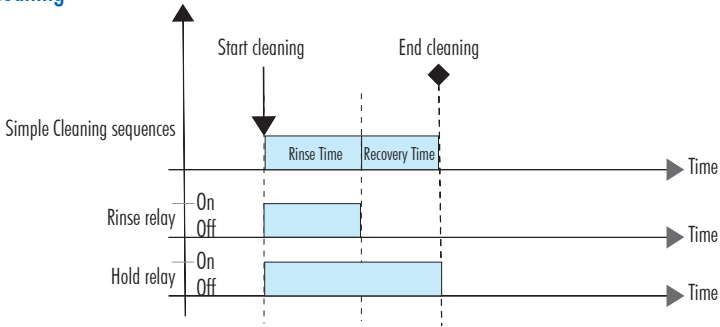

Figure 48: Cleaning Algorithm, Simple Cleaning

Advanced Cleaning

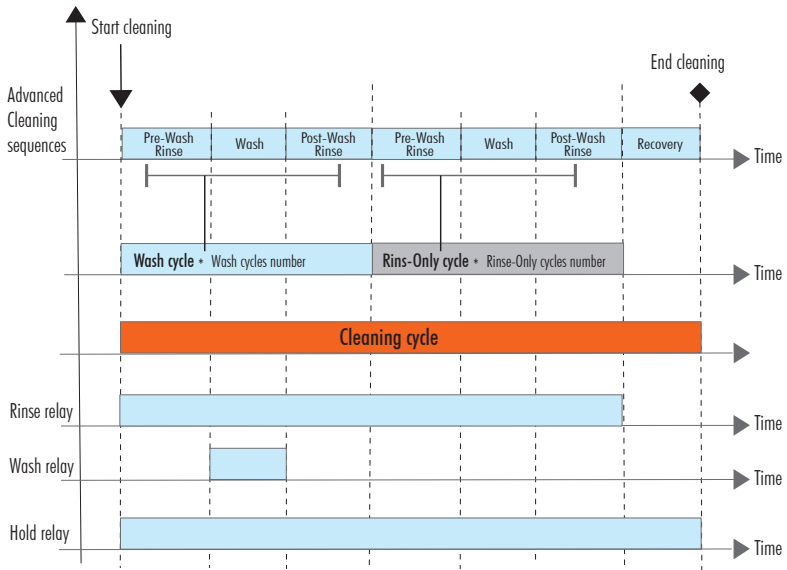

Figure 49: Cleaning Algorithm, Advanced Cleaning

19.5. CLEANING TRIGGERS

External input

The external digital inputs are set to start cleaning process. Transition of external digital inputs from an inactive to active level will start the cleaning.

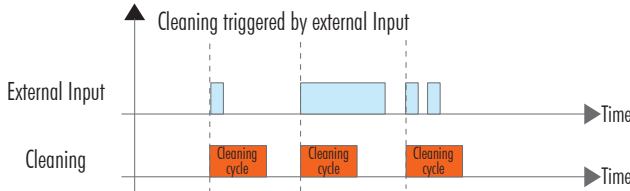

Figure 50: Cleaning Trigger, External Input

Internal timer

Cleaning starts at fix intervals, prompted by an internal timer.

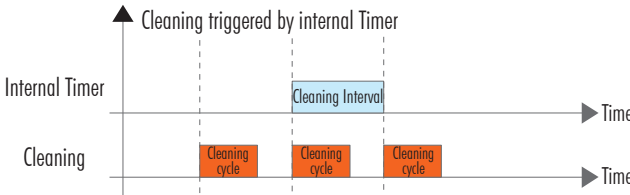

Figure 51: Cleaning Trigger, Internal Timer

Internal schedule

Cleaning starts at exact times, with a maximum of three start times per day.

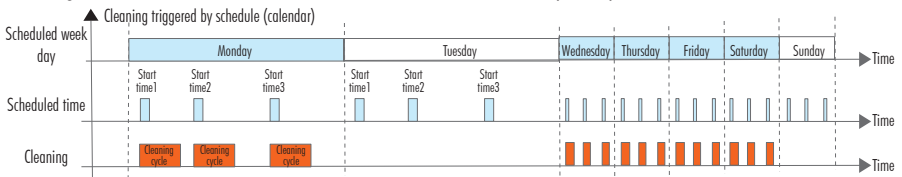

Figure 52: Cleaning Trigger, Internal Schedule

Operator intervention

Cleaning starts by pressing the left virtual key on keypad when in Menu, Cleaning menu item selected. Cleaning should have been enabled previously.

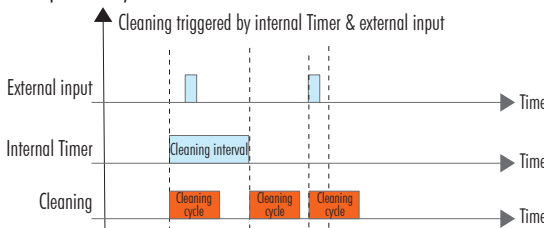

Figure 53: Cleaning Trigger, Operator Intervention

Triggered by a combination of external input & internal timer or schedule

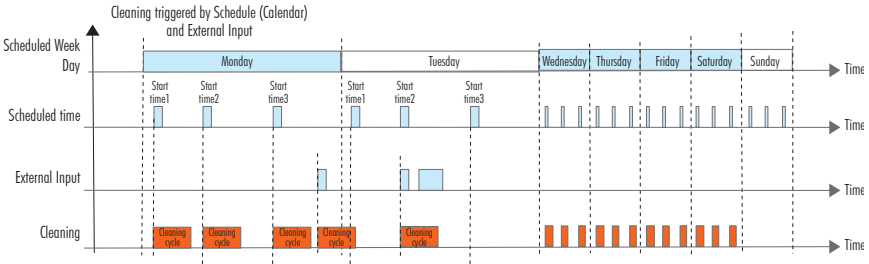

Figure 54: Cleaning Trigger, External Input & Internal Timer

19.6. STOP CLEANING

Navigation

- Press and hold the keys together to terminate a cleaning.
- During cleaning with the controller in normal measurement mode, the countdown timer will be displayed on the second LCD line.

A complete rinsing phase (post-rinse time) is always performed before terminating an advance cleaning. If the request to stop the cleaning is issued during rinsing, the rinsing phase is carried out to completion.

Note: Calibration can't be performed during cleaning; conversely, cleaning can't be triggered during calibration.

A cleaning cycle can be stopped:

- At the end of a cleaning sequence, with the next cycle being triggered as per configured cleaning triggers.
- At a stop command, with the current cycle being shortened to a maximum time, no higher than the sum of a single rinse and recovery time. Next cycle will start as per configured cleaning triggers.

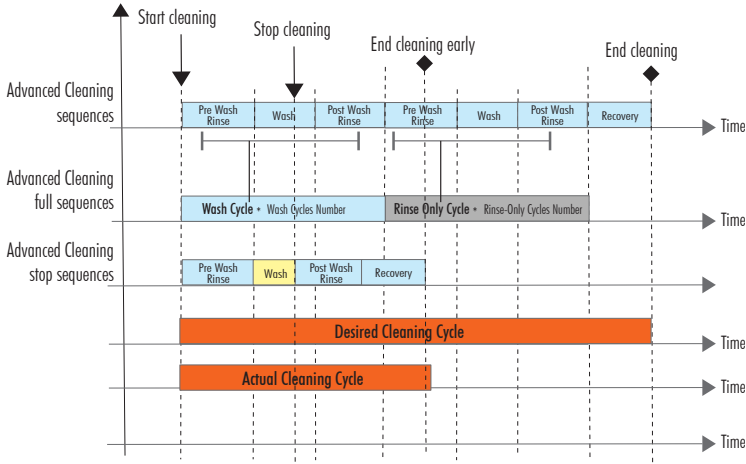

Figure 55: End Cleaning, Stop Sequences

- At a suspend condition, with the current cycle being shortened to a maximum time, no higher than the sum of a single rinse and recovery time. Next cycle to start only after suspend condition is removed.

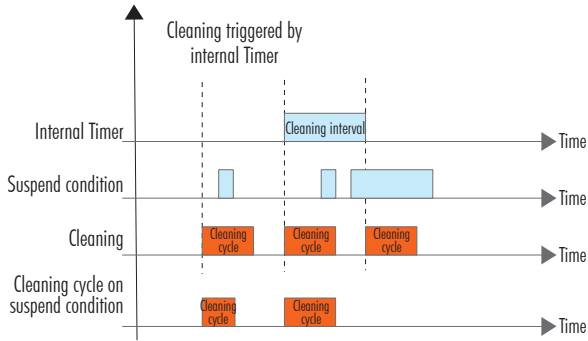

Figure 56: End Cleaning, Suspend Condition

- At a transition to manual mode. Cleaning cycle is stopped instantly. After exiting from manual mode, cleaning will continue with a rinse and a recovery phase.

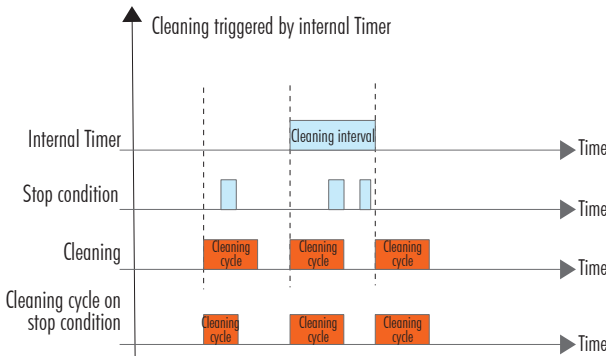

Figure 57: End Cleaning, Stop Condition

20. HI520 EVENTS MANAGEMENT SYSTEM

HI520 has an intuitive and user friendly events management system that allows for quick and easy event -source identification.

Status and **Hold LEDs** located on the right side of the controller's front panel as well as **Alarm** and **Relay LEDs** located on the left side, notify the instrument status.

The HI520 LED notification system is shared across the two independent control loops that run simultaneously. It is possible to have alarm and warning notifications on one channel and active, running status on the other.

LED	LED notification light	HI520 status as signaled by LED notification light
Status	Green (●)	Measure mode
	Yellow (●)*	Warning
	Red (●)**	Errors or Alarms
Hold	Yellow (●)	Requires user attention
Alarm	Red (●)	Alarm relay ON
Relay	Blue (●)	Active status

* Controller requires user attention

** Controller requires specialized technical assistance

ALARMS, WARNINGS, ERRORS

Alarms

An alarm is an event generated when programmed alarm conditions have been met.

HI520 alarm system is made of:

- **Default alarms:** generated during a measurement cycle when measured values have exceeded or dropped below probe ranges limits
- **Configured alarms:** generated when measured values have exceeded values configured for each parameter and Temperature (in Setup, Channel, Alarm Settings)
- **Acoustic signal (beep/buzz):** when enabled in General setup, it is generated each time an alarm is triggered. The signal can be stopped by pressing any key.

Warnings

A warning is an event generated when erroneous conditions appear; and when measured values or parameter values, configured in the main Menu, are outside the expected range.

Errors

An error is a critical event that requires Hanna Instruments® technical support.

Note: All alarm, warning, and error events are logged in the event log.

ALARMS

Analog Output (AO) behavior

- AO assigned to Ctrl.SetPoint — scaled value of Ctrl.SetPoint output
- AO assigned to parameter — scaled value of parameter or 22 mA, if this option is enabled

Alarm	Description	Continue Logging	Stop Control	Alarm Relay & LED	Status LED	Hold Relay & LED
ALARM_HIGH_CH1_PRIMARY ALARM_HIGH_CH2_PRIMARY	Generated during measurement when main reading is over set Alarm High value.	YES	YES*	On ●	●	On ●
ALARM_LOW_CH1_PRIMARY ALARM_LOW_CH2_PRIMARY	Generated during measurement when main reading is below set Alarm Low value.	YES	YES*	On ●	●	On ●
ALARM_HIGH_CH1_SECONDARY ALARM_HIGH_CH2_SECONDARY	Generated during measurement, with temp. control set, when read temp. value is over set temp. alarm high value.	YES	YES**	On ●	●	On ●
ALARM_LOW_CH1_SECONDARY ALARM_LOW_CH2_SECONDARY	Generated during measurement, with temp. control set, when read temp. value is below set temp. alarm low value.	YES	YES**	On ●	●	On ●
ALARM_OVER_RANGE_CH1_PRIMARY ALARM_OVER_RANGE_CH2_PRIMARY	Generated during measurement when probe main reading is over the range.	YES	YES*	On ●	●	On ●
ALARM_UNDER_RANGE_CH1_PRIMARY ALARM_UNDER_RANGE_CH2_PRIMARY	Generated during measurement cycle when probe main reading is in under range status.	YES	YES*	On ●	●	On ●
ALARM_OVER_RANGE_CH1_SECONDARY ALARM_OVER_RANGE_CH2_SECONDARY	Generated during measurement cycle when probe temp. reading is over the range.	YES	YES** & ***	On ●	●	On ●
ALARM_UNDER_RANGE_CH1_SECONDARY ALARM_UNDER_RANGE_CH2_SECONDARY	Generated during measurement cycle when probe temp. reading is in under range status.	YES	YES** & ***	On ●	●	On ●

* Control stopped on loop that controls the primary parameter

** Control stopped on loop that controls temperature

*** Control of main parameter is enabled because temperature parameter has been replaced with a fixed value

Note for *, ** or *:** Hold Relay&LED will be activated only if corresponding parameter is configured as active control parameter within Control Settings (SetP1 or SetP2)

Alarm	Description	Continue Logging	Stop Control	Alarm Relay & LED	Status LED	Hold Relay & LED
ALARM_OVERTIME_CH1_SP1 ALARM_OVERTIME_CH1_SP2 ALARM_OVERTIME_CH2_SP1 ALARM_OVERTIME_CH2_SP2	Generated when the control does not reach the SP1 or SP2 value after configured time has passed.	YES	YES	On ●	✶	On ●
ALARM_CH1_PROBE_RECONNECT ALARM_CH2_PROBE_RECONNECT	Generated each time probe is reconnected.	YES	YES	Off ●	●	On ●
ALARM_CH1_NO_PROBE ALARM_CH2_NO_PROBE	Generated if no probe connected.	NO	YES	On ●	✶	On ●
ALARM_CH1_NO_PARAM_LOADED ALARM_CH2_NO_PARAM_LOADED	Probe parameters not fully loaded. Check probe connection/wiring.	NO	YES	On ●	✶	On ●
ALARM_CH1_PROBE_ERROR ALARM_CH2_PROBE_ERROR	Probe is not measuring/reading correctly.	NO	YES	On ●	✶	On ●
ALARM_MAIN_POWER_FAILED	Generated at power Off/On.	NO	YES	Off ●	●	On ●
ALARM_HIGH_MATH_CHANNEL	Generated during measurement, when math channel value is over set math channel alarm high value.	YES	NO	On ●	✶	Off ●
ALARM_LOW_MATH_CHANNEL	Generated during measurement, when math channel value is under set math channel alarm high value.	YES	NO	On ●	✶	Off ●
HOLD ALARMS	HOLD input condition is present (alarm hold); event message is "Hold Ext."	YES	YES	On ●	✶	On ●
	Generated manual (silent hold); event message "Hold Manual"	YES	YES	Off ●	●	On ●
	Generated by Menu /User cal. (silent hold) and not registered in event log.	YES	YES	Off ●	●	On ●
ALARM_TEMP_SENSOR_BROKEN	Temp. sensor not working. Probe is working with "Man. Temp. Value" configured in Setup.	YES	YES** & ***	On ●	✶	Off ●

** Control stopped on loop that controls temperature

*** Control of main parameter is enabled because temperature parameter has been replaced with a fixed value

Note for **: Hold Relay&LED will be activated only if corresponding parameter is configured as active control parameter within Control Settings (SetP1 or SetP2)

WARNINGS

Analog Output (AO) behavior: as configured

Warning	Description	Continue Logging	Stop Control	Alarm Relay & LED	Status LED	Hold Relay & LED
WARNING_PROBE1_UCAL_EXP WARNING_PROBE2_UCAL_EXP	Outdated user/process calibration. Calibration is mandatory.	NO	NO	Off ●	●	Off ●
WARNING_PROBE1_NO_UCAL WARNING_PROBE2_NO_UCAL	Generated prior to calibration indicating probe calibration is mandatory.	NO	NO	Off ●	●	Off ●
WARNING_PROBE1_UCAL_EXP_SOON WARNING_PROBE2_UCAL_EXP_SOON	User/process calibration is due soon. Configured calibration time out period due to be exceeded (5 % calibration alarm timeout days before).	NO	NO	Off ●	●	Off ●
WARNING_HIGH_CH1_PRIMARY WARNING_HIGH_CH2_PRIMARY	Primary parameter exceeds primary parameter ALARM High set value. Mask time has not yet expired to generate an alarm. Check tanks and all installed devices are functioning correctly.	NO	NO	Off ●	●	Off ●
WARNING_LOW_CH1_PRIMARY WARNING_LOW_CH2_PRIMARY	Primary parameter is below primary parameter ALARM High set value. Mask time has not expired to generate an alarm. Check tanks and all installed devices are functioning correctly.	NO	NO	Off ●	●	Off ●
WARNING_HIGH_CH1_SECONDARY WARNING_HIGH_CH2_SECONDARY	Secondary parameter is over secondary parameter ALARM High set value. Mask time has not yet expired to generate an alarm.	NO	NO	Off ●	●	Off ●
WARNING_LOW_CH1_SECONDARY WARNING_LOW_CH2_SECONDARY	Secondary parameter is below secondary parameter ALARM High set value. Mask time has not yet expired to generate an alarm.	NO	NO	Off ●	●	Off ●

Warning	Description		Continue Logging	Stop Control	Alarm Relay & LED	Status LED	Hold Relay & LED
WARNING_CH1_ODO_CAP_TIMEOUT	HI7640-58 Optical DO only	Expired Smart Cap. Replace the Cap.	NO	NO	Off ●	● ●	● ●
WARNING_CH1_ODO_CAP_TIMEOUT_SOON		Smart Cap expires soon. Cap is due for replacement.	NO	NO	Off ●	● ●	● ●
WARNING_RTC_SET_TO_FIRST_VALUE	RTC is running.		NO	NO	Off ●	● ●	● ●
WARNING_LOT_LOG_FULL	Current lot log file has reached 8600 records. A new file will be generated automatically and old data deleted. Save current data on USB and delete the file to prevent data loss.		NO	NO	Off ●	● ●	● ●
WARNING_LOT_LOG_MAX_INDEX_ASSIGNED	Maximum number of logged files per day has been reached (100). Save current data on USB and delete the file to prevent data loss.		NO	NO	Off ●	● ●	● ●
WARNING_HIGH_MATH_CHANNEL	Primary parameter exceeds math channel High set value. Mask time has not yet expired to generate an alarm. Check tanks and all installed devices are functioning correctly.		NO	NO	Off ●	● ●	● ●
WARNING_LOW_MATH_CHANNEL	Secondary parameter is below secondary parameter math channel High set value. Mask time has not yet expired to generate an alarm.		NO	NO	Off ●	● ●	● ●
WARNING_CONTROL_DELAY	Start up is delayed and control is not running.		NO	NO	Off ●	● ●	● ●
WARNING_MAIN_OUTOFF_COMPRANGE	Main parameter is outside compensation range.		NO	NO	Off ●	● ●	● ●
WARNING_TEMP_OUTOFF_COMPRANGE	Temperature outside compensation range		NO	NO	Off ●	● ●	● ●
WARNING_TEMP_SENSOR_BROKEN	Temperature sensor not working. Replace the probe.		NO	NO	Off ●	● ●	● ●

ERRORS

When encountered, restart the controller. If the error persists, contact Hanna Instruments® technical support.

Error	Description	Continue Logging	Stop Control	Analog Output (AO) Behavior		Alarm Relay & LED	Status LED	Hold Relay & LED
				0-20 mA	4-20 mA			
ERROR_EEP_CTRL_CHECKSUM	Incorrect EEPROM checksum.	YES	YES	0	4	●	●	●
ERROR_FLASH_CTRL	SD CARD interface doesn't work correctly.	NO	NO	functional		●	●	Off
ERROR_FLASH_CTRL_MFS	File management system error Restart the controller. If the error is solved, save log and event files, then delete all files.	NO	NO	functional		●	●	Off
ERROR_IO_POWER	24V IO power failure	YES	YES	0	4	●	●	●
ERROR_RS485_POWER	RS-485 interface power failure.	YES	NO	functional		●	●	Off
ERROR_MICRO_TEMP	Microprocessor temperature is too high. Power off the controller, wait 15 min. Power back on.	YES	NO	functional		●	●	●
ERROR_PROBE_NO_FCAL	Corrupt probe factory calibration. Replace the probe. Note: Control for SetP1 is disabled.	YES	YES	0	4	●	●	●
ERROR_CH1_ODO_NO_TAG ERROR_CH2_ODO_NO_TAG	HI7640-58 Optical DO only	NO	YES	0	4	●	●	●
ERROR_CH1_ODO_BAD_MEMBRANE ERROR_CH2_ODO_BAD_MEMBRANE		NO	YES	0	4	●	●	●
ERROR_CH1_ODO_CORRUPT_CAP ERROR_CH2_ODO_CORRUPT_CAP		NO	YES	0	4	●	●	●
ERROR_CH1_ODO_NO_CAP ERROR_CH2_ODO_NO_CAP		NO	YES	0	4	●	●	●
ERROR_CH1_ODO_INCOMPATIBLE_CAP ERROR_CH2_ODO_INCOMPATIBLE_CAP		NO	YES	0	4	●	●	●
ERROR_CH1_ODO_SPI_ERROR ERROR_CH2_ODO_SPI_ERROR		NO	YES	0	4	●	●	●
ERROR_ODO_EPIRED_CAP		NO	YES	0	4	●	●	●
		Generated when Smart Cap has expired.	NO	YES	0	4	●	●

FATAL ERRORS

Errors that prevent the controller from operating.

When encountered, restart the controller. If the error persists, contact Hanna Instruments technical support.

Fatal Error	Event Code	Description	Continue Logging	Stop Control	Analog Output (AO) Behavior		Alarm Relay & LED		Hold Relay & LED
					0-20 mA	4-20 mA	Status LED		
ERROR_EEP_CTRL	0x00001	EEP interface circuit doesn't work correctly	NO	YES	0	4	●	●	●
ERROR_EEP_AO_FC	0x00002	Corrupt AO factory calibration	NO	YES	0	4	●	●	●
ERROR_EEP_PRESSURE_FC	0x00010	Corrupt pressure factory calibration	NO	YES	0	4	●	●	●
ERROR_EEP_SN	0x00040	Corrupt SN	NO	YES	0	4	●	●	●
ERROR_5V_POWER	0x00200	5V power failure	NO	YES	0	4	●	●	●
ERROR_AO_POWER	0x04000	24V AO power failure	NO	YES	0	4	●	●	●

21. MEASURING WITH pH & ORP PROBES

21.1. GENERAL INSTALLATION CONSIDERATIONS

- Probes are easily installed using the 3/4" NPT external thread.
- Hand tighten the probe in position. Then, depending on the process, tighten one or two turns with a wrench to secure in place. Do not exceed the 10 N•m (7.3 lb-ft) torque specification for the probe sensor.
- Protect the probe and membrane from strong flow to prevent unstable readings.
In turbulent aeration basin installations, place the probe in a weir for more accurate readings.
- Do not install the probe in an upside-down position.
- Provisions must be made for the removal of the probe from the process.
- Consider probe accessibility for maintenance when selecting placement.

Note: See pH and ORP industrial probes manuals (MAN10X6-8 and MAN20X4-8) for series configuration and detailed specifications.

21.2. INSTALLATION SCHEMES & MOUNTING ACCESSORIES

Accessories are sold separately!

In-line mounting and flow-cell installation require that the saddle and flow cell are completely filled with water.

21.2.1. Probe Dimensions

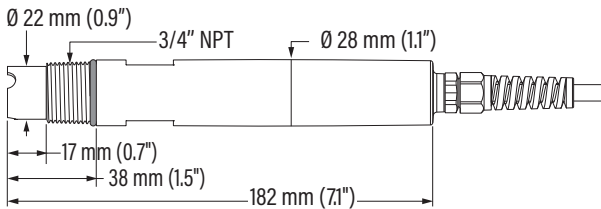

Figure 58: HI1006-18zz industrial pH probe with attached cable

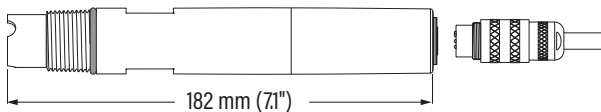

Figure 59: HI1006-1800 industrial pH probe with DIN connector

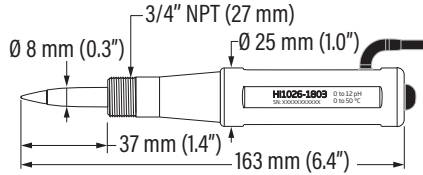

Figure 60: HI1026-1803 pH probe for specific meat applications

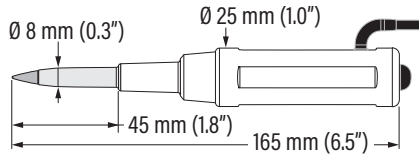

Figure 61: HI1126-1805 pH probe for general food applications

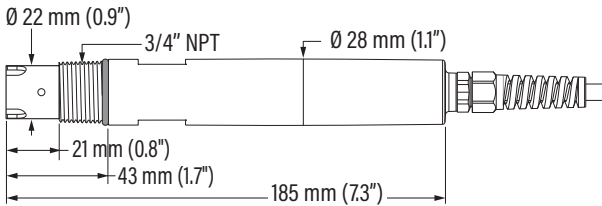

Figure 62: HI2004-18zz industrial ORP with attached cable

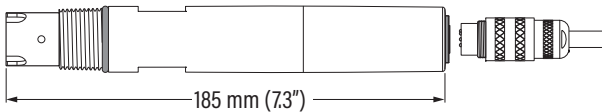
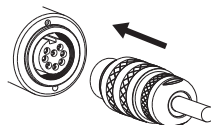

Figure 63: HI2004-1800 industrial ORP with DIN connector

21.2.2. Probe Connection

Align the pins and key then push the plug into the socket.

Rotate the collar to lock in place.



Note: Probe connection (probe with integral DIN connector) and probe wiring (probe with attached cable) **must be** carried out with the controller **disconnected** from power.

21.2.3. In-line Mounting with Probe Saddle

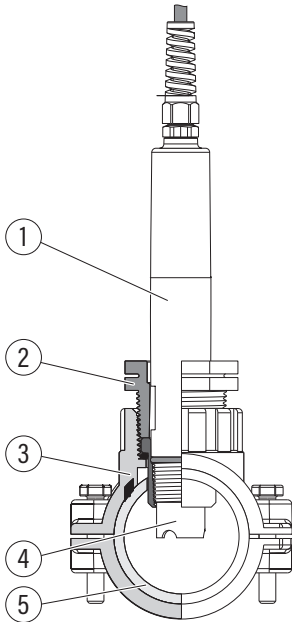

- | | |
|---|-------------------|
| 1 | Probe |
| 2 | Probe fitting kit |
| 3 | Saddle |
| 4 | Sensor tip |
| 5 | Pipe |

Note: probe can be rotated to prevent air entrapment inside the electrode.

Mounting accessories

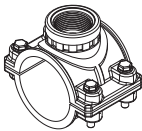

Pipe size	Saddle code	HI10x6-y8ZZ	HI20x4-Y8zz
Ø 50 mm (2")	BL120-550	<input checked="" type="checkbox"/>	<input checked="" type="checkbox"/>
Ø 63 mm (2½")	BL120-563	<input checked="" type="checkbox"/>	<input checked="" type="checkbox"/>
Ø 75 mm (3")	BL120-575	<input checked="" type="checkbox"/>	<input checked="" type="checkbox"/>

21.2.4. Tank Immersion with Submersible Electrode Holder

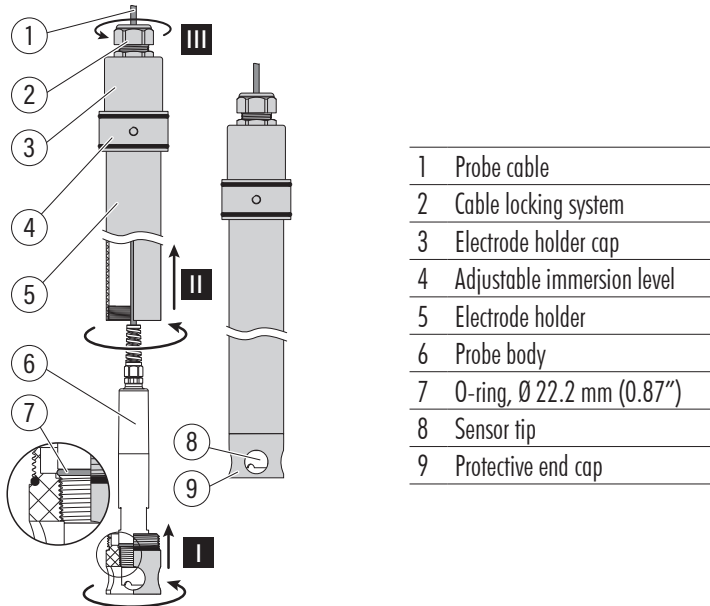

The **HI60501/HI60503** (PVC/PVDF submersible holders) and **HI605011** (mounting flange) provide a sturdy housing that prevents the probe from being damaged. For high-temperature or complex chemical processes it is recommended the use of PVDF accessories.

To install the probe:

- A. Unscrew the protective end cap (9).
The cap allows for quick and simple probe maintenance and replacement.
- B. Slide out the electrode holder cap (3).
- C. Screw the probe into the internally threaded protective cap (9), step I.
- D. Screw the probe and protective cap subassembly onto the holder (5), step II.
- E. Feed the probe cable through the holder (5) and out through the cap (3) and cable gland on top (2). The cable is shielded inside the holder to prevent any damage to the insulation.
- F. Tighten the cable gland (2), step III, and slide the cap (3) back onto the holder (5).

21.2.5. Flow-cell Installation

Do not allow deposits of sediment or other foreign material to accumulate within the sensing area.

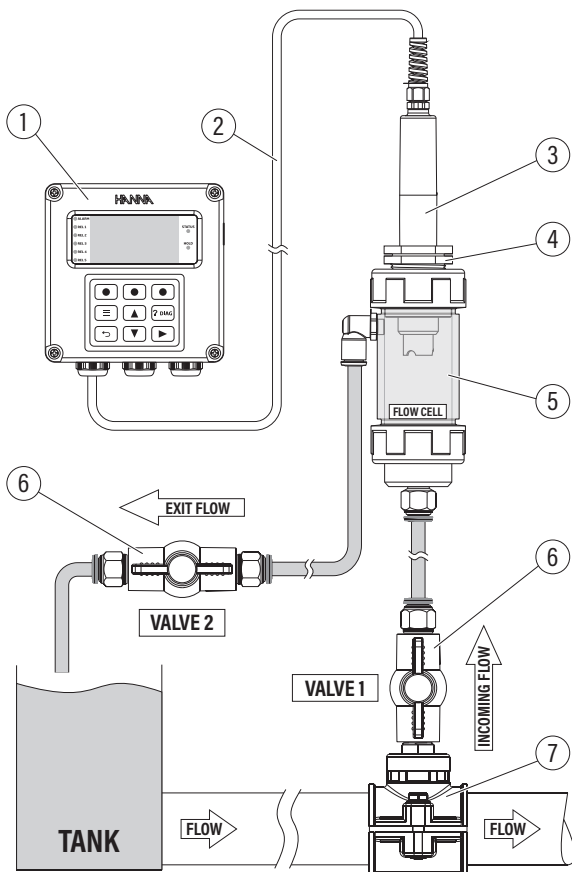

- | | |
|---|--------------------|
| 1 | Process controller |
| 2 | Wiring cable |
| 3 | pH probe |
| 4 | Flow-cell adapter |
| 5 | Flow cell |
| 6 | Flow-cell valves |
| 7 | Saddle |

21.3. CONFIGURABLE MEASUREMENT PARAMETERS

Resolution

Option: 0.01 pH, 0.1 pH

- With Resolution selected, press **Modify**.
- Use the **▲** **▼** keys to navigate between the two possible options.

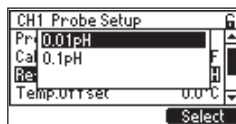
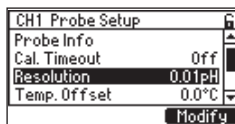

Note: Resolution only affects the displayed pH measurement.

Temperature Source (Temp. Source)

Option: Probe, Manual

- With item selected, press **Modify**.
- Use the **▲** **▼** keys to select Probe or Manual for temperature source.
- Press **Select** to save the option.

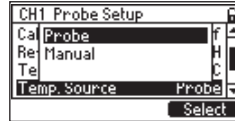
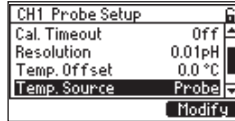

Manual Temperature Value (Man. Temp. Value)

Default value is 25 °C

- With item selected (and Temp. Source set to Manual), press **Set** to modify the value.
- Use the **▲** **▼** keys to modify the flashing value.
- Press **CFM**, to save.

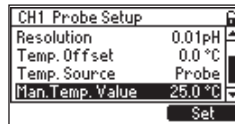

Cal. Buffer Group

pH option only: Hanna, NIST

- With item selected, press **Modify**.
- Use the **▲** **▼** keys to select between Hanna or NIST buffers.
- Press **Select** to save the option.

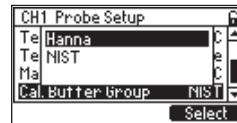
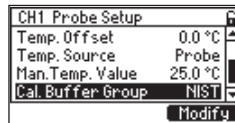
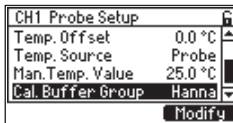

21.4. CALIBRATION

Navigation:

- Press **☰** from the Measure mode.
- With Channel selected, press **CAL**, to enter calibration.

Calibration mode allows users to calibrate the installed probe.

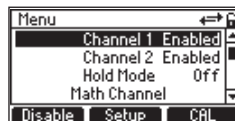

The probe should be calibrated:

- Before installation
- Whenever the probe is replaced
- When higher accuracy is required
- After periodic maintenance
- After calibration TimeOut has expired

21.4.1. pH Probes Calibration

HI520 process controller allows two types of pH calibration procedures:

- **Standard** calibrations performed in standard buffer solutions
 - ▶ Hanna Instruments: 1.68, 4.01, 7.01, 10.01, 12.45 pH
 - ▶ NIST: 1.68, 4.01, 6.86, 9.18, 12.45 pH
- **Process** calibrations performed with probes calibrated in standards and installed in the process.

Note: See 6.2 Probe Settings, General Parameters section for TempOffset section.

Preparation Guidelines

Calibrations performed in standard buffers follow the preparation guidelines detailed below.

- Pour a minimum 50 mL of the buffer solutions into clean beakers.
If possible, use plastic beakers to minimize any EMC interferences.
- For accurate calibrations and to minimize cross-contamination, use two beakers for each buffer solution: one for rinsing the probe and one for calibration.
- On the controller, go to Channel setup, Probe Setup, Cal.Buffer Group to select buffer group.
- Up to three pH buffers may be used for a calibration.
At least two buffers are required to determine a pH slope.

Note: It is recommended to select buffers that bracket the expected process pH.

pH Standard Calibration

One-, two- or three-point calibration can be performed using one of the buffer solutions selected from one of the two groups.

It is generally recommended to use 7.01 or 6.86 pH buffer as first calibration point.

When the electrode is immersed into buffer solution, the controller automatically recognizes the buffer value.

One-Point

1. Press **CAL**, to enter calibration mode.
2. At prompt, with the password enabled, input the passcode.
3. The first suggested buffer solution “7.01 pH” (if using Hanna Instruments buffer group) or “6.86 pH” (if using NIST buffer group) is displayed in the upper left of the display window.
4. Immerse the pH probe approximately 4 cm (1½”) into buffer solution and stir gently.

The controller automatically recognizes the standard and the recognized buffer value is displayed on the LCD.

- Press **CLR**, to delete a previous calibration or **Process**, to enter process calibration.

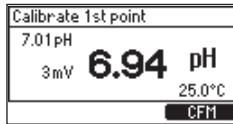

- When the reading is stable, **CFM** is displayed. Press **CFM**, to save. "Wait" is displayed at the bottom of the LCD screen until calibration is saved. After the first point is accepted, "Calibration point is accepted and saved" is displayed.
- Select **Next**, to continue with a two-point calibration or **Exit**, to save the calibration and return to the menu.

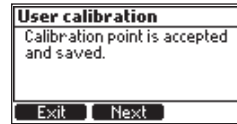
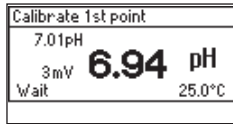
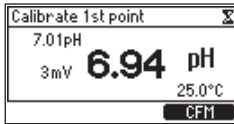

Two-Point

- After completing the one-point calibration, press **Next** to continue calibrating in a second buffer.
- Immerse the pH probe in the second calibration buffer. The buffer solution is 4.01 pH, displayed flashing, but will change to the buffer used once recognized.
- When the buffer is recognized and the reading is stable, the buffer value stops flashing and **CFM** is displayed. Press **CFM**, to save. "Wait" is displayed at the bottom of the LCD screen until calibration is saved. After the second point is accepted, "Calibration point is accepted and saved" is displayed.
- Select **Next**, to continue with a three-point calibration or **Exit**, to return to the menu.

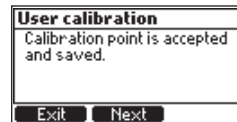
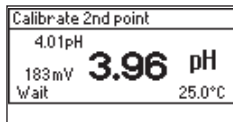
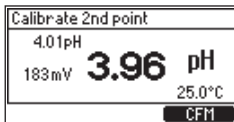

Three-Point

- Follow two-point calibration steps and press **Next** when prompted.
- Immerse the pH probe in the third calibration buffer. The buffer solution will be recognized and displayed flashing.
- When the reading is stable, the buffer value stops flashing and **CFM** is displayed. Press **CFM**, to save. "Wait" is displayed at the bottom of the LCD screen until calibration is saved. "DONE" confirmation message is displayed on last LCD line.

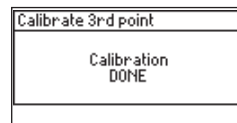
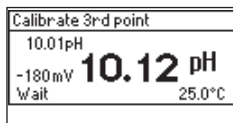
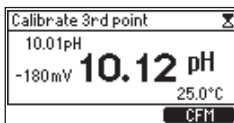

Note: One-point calibration evaluates electrode offset whereas a two- or three-point calibration evaluates both electrode offset and slope.

If Next is selected, to continue with a two- or three-point calibration, the buffer value proposed next is displayed flashing, until the probe is immersed in the selected buffer solution. User can select from any of the buffer solutions not yet used for calibration.

pH Process Calibration

Prior to performing a process calibration, use a calibrated portable pH meter and probe to determine the pH of the process and write down the value.

pH process calibration is a single point calibration, performed while the probe remains installed in the process. Users can adjust the measured process pH value (± 0.5 pH) so that it matches the value determined with the reference instrument.

1. Press **CAL**, to enter calibration mode.
2. At prompt, enter the passcode.
3. Once unlocked, press **CAL** again.
4. Press **Process**, to enter process calibration.

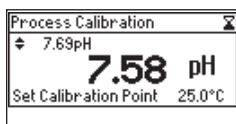
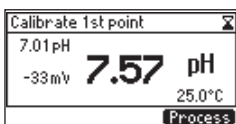
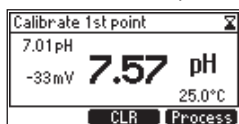

5. Use the   keys to adjust the value to the one determined with the hand held meter.

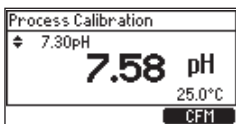

6. When the reading is stable, **CFM** is available. Press **CFM** to save the calibration.

“Wait” is displayed at the bottom of the LCD screen until the calibration point is memorized.

“DONE” confirmation message is displayed for a few seconds.

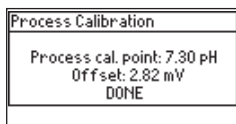
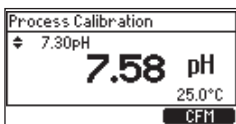
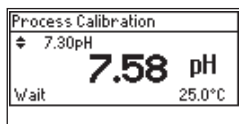

Note: Process calibration evaluates electrode offset.

21.4.2. ORP Probes Calibration

ORP calibration is a **single point calibration** that can be performed with the probe installed in the process or with the probe removed from the process.

Preparation Guidelines

Probe removed from the process

- Rinse the probe with deionized water and pat it dry with a lint-free cloth prior to calibration.
- Submerge the electrode tip (4 cm/1½") into the sample to be tested.
- Do not let the probe touch the bottom or sides of the container.
- Remove the air bubbles from under the probe tip. Stir the sample at a slow to moderate rate and wait a few seconds for the reading to stabilize.

Note: ORP calibration standards may be used with the probe directly i.e. 240 mV (HI7021 ORP test solution for platinum and gold electrodes) or 470 mV (HI7022 ORP and test solution for platinum and gold electrodes).

Probe installed in the process

- Use a calibrated portable ORP meter to determine the value of the process and write down the value.

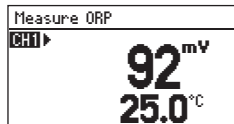

Note: mV measurements are generated by the ORP electrode and displayed with 1 mV resolution.

Procedure

An ORP calibration is a single point calibration. The calibration point value is displayed, and the value can be adjusted ± 60 mV around the measured mV.

If an ORP calibration standard is used, the probe is removed from the process, cleaned off then placed in a beaker with the standard.

1. Press **CAL** when the instrument is in mV measurement mode. The mV value is displayed.
2. Press the **▲** **▼** keys to adjust the value.
3. After the reading has stabilized and the mV offset is inside the offset window, **CFM** virtual key is displayed. Press **CFM**, to confirm ORP calibration.

The instrument will return to the main menu.

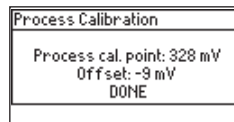
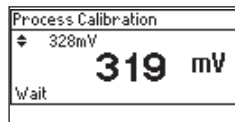
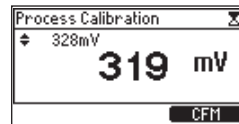
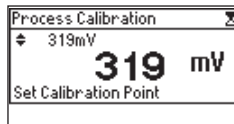
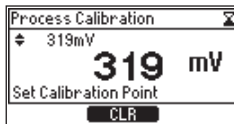

21.4.3. Clear pH (ORP) Calibration

1. Press **CAL**, to enter calibration mode.
2. **CLR** option is displayed for a few seconds.

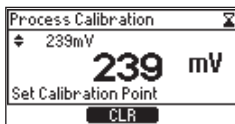
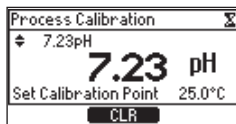

3. Press **CLR**, to clear previous calibration.

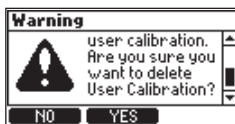
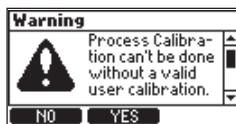

4. Press **Yes**, to confirm deletion.

21.4.4. pH Calibration Messages & Warnings

Message & Description	Recommended Action
<p>Calibrate 2nd point 4.01pH 140mV 4.63 pH Invalid Slope 25.0°C</p>	<p>"Invalid Slope" The electrode slope is outside accepted slope limit. Calibration can not be confirmed.</p>
<p>Calibrate 3rd point 10.01pH -219mV 10.98 pH Invalid Slope 25.0°C</p>	
<p>Calibrate 1st point 7.01pH 16mV 6.72 pH Clean Electrode 24.4°C CFM</p>	<p>"Clean Electrode" The offset, evaluated at first calibration point, is outside the accepted window; or the slopes, evaluated between calibration points, are outside the accepted lower limit. Calibration can be confirmed.</p>
<p>Calibrate 1st point 12.45pH -358mV 12.78 pH Wrong Old 25.0°C CLR</p>	<p>"Wrong Old" The slope evaluated based on a comparison between new and old calibration points is outside the accepted limits.</p>
<p>Calibrate 1st point 7.01pH 9mV 7.00 pH Temperature error -4.0°C CLR</p>	<p>"Temperature Error" The temperature of the buffer solution is outside accepted temperature solution interval.</p>
	<p>Verify the probe is in the buffer selected and that the buffer is fresh.</p> <p>Clean the probe to improve the pH electrode's response. See 21.5 Conditioning & Maintenance for details. Repeat calibration after cleaning.</p> <p>Clear calibration and proceed with a new one.</p> <p>Check buffer temperature and repeat the measurement.</p>

21.5. CONDITIONING & MAINTENANCE

General Maintenance

- After prolonged storage or cleaning, calibration of the probe is required.
- After use, rinse the probe with tap water and dry it.
- Inspect all sensor connectors for corrosion, replace if necessary.

Periodic Maintenance

- Inspect the electrode for any scratches or cracks. If any are present, replace the electrode.
- Inspect the cable. The connection cable must be intact.
- Rinse off any salt deposits with water.

pH & ORP Sensor Maintenance

- Remove the sensor protective cap. Do not be alarmed if any salt deposits are present. This is normal with pH / ORP probes and they will disappear when rinsed with water.
- Shake down the probe to eliminate any air bubbles inside glass bulb.
- If the bulb and / or junction are dry, soak the electrode in [HI70300](#) Storage solution for at least 30 minutes
- To ensure a quick response, the glass bulb and the junction should be kept moist and not allowed to dry. This can be achieved by installing the electrode in such a way that it is constantly in the flow-cell or the pipe filled with the sample.
- Store the sensor with a few drops of [HI70300](#) Storage solution or pH 4.01 in the protective cap.
- ORP electrodes
 - ▶ In case of errors or faulty/fluctuating readings, gently polish the metal tip with a lightly abrasive paper, paying attention not to scratch the surface. Follow with a thorough wash.

Note: Never use distilled or deionized water when stored.

pH Cleaning Procedure

1. Soak the sensor in [HI7061](#) Electrode cleaning solution for general use or application-specific cleaning solution for 15 minutes (i.e. [HI7073](#) Protein cleaning, [HI7074](#) Inorganic cleaning, [HI7077](#) Oil and Fat cleaning solution).
2. Rinse the sensor with water.
3. Soak the electrode in [HI70300](#) Storage solution for at least 30 minutes, rinse with water and calibrate before using.

Protein, Inorganic, Oil, or Grease Cleaning Procedure

1. Soak the sensor in application specific electrode cleaning solution for 15 minutes (i.e. [HI7073](#) Protein cleaning, [HI7074](#) Inorganic cleaning or [HI7077](#) Oil & Fat cleaning solution).
2. Rinse the sensor with water.

IMPORTANT: After performing any of the cleaning procedures, rinse the electrode thoroughly with water and soak in [HI70300](#) Storage solution for at least 30 minutes before calibrating it.

Storage

- When the pH probe is removed from the process for more than 1 hour, fill the protective cap with [HI70300](#) Storage solution and tighten the cap on the sensor. Never store the probe in distilled or deionized water.

22. MEASURING WITH EC PROBES

22.1. GENERAL INSTALLATION CONSIDERATIONS

- Probes are easily installed using the 3/4" NPT external thread.
- Hand tighten the probe in position. Then, depending on the process, tighten one or two turns with a wrench to secure in place. Do not exceed the 10 N•m (7.3 lb-ft) torque specification for the probe sensor.
- Consider probe accessibility for maintenance when selecting placement.

Note: See EC industrial probes manual (MAN7630-8) for series configuration options and detailed specifications.

22.2. INSTALLATION SCHEMES & MOUNTING ACCESSORIES

Accessories are sold separately!

In-line mounting and flow-cell installation require that the saddle and flow cell are completely filled with water.

22.2.1. Probe Dimensions

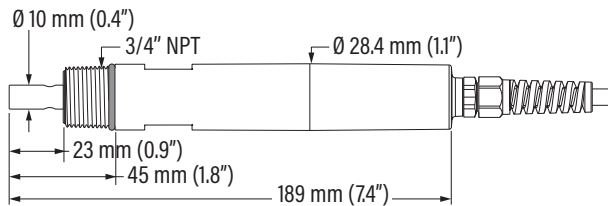

Figure 64: HI7630-28zz two-electrode EC probe with attached cable

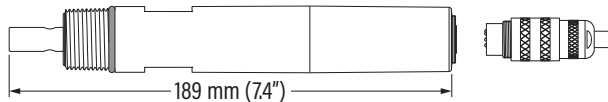

Figure 65: HI7630-2800 two-electrode EC probe with DIN connector

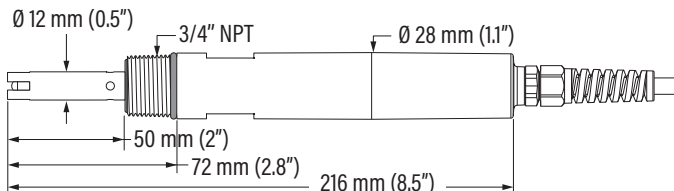

Figure 66: HI7630-48zz four-ring EC probe with attached cable

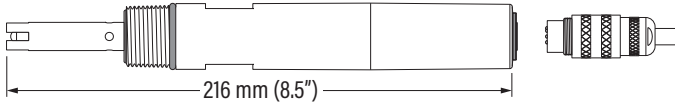
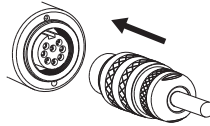

Figure 67: HI7630-4800 four-ring EC probe with DIN connector

22.2.2. Probe Connection

Align the pins and key then push the plug into the socket.
 Rotate the collar to lock in place.



Note: Probe connection (probe with integral DIN connector) and probe wiring (probe with attached cable) **must be** carried out with the controller **disconnected** from power.

22.2.3. In-line Mounting with Probe Saddle

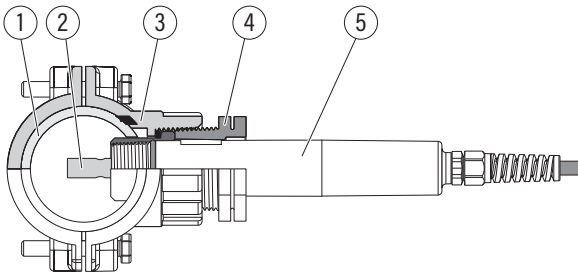

1	Pipe
2	Sensor tip
3	Saddle
4	Probe fitting kit
5	Probe

Note: To prevent air entrapment inside the electrode the probe can be rotated and horizontal mounting is the recommended option.

Required accessories

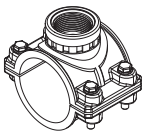

Pipe size	Saddle code	HI7630-28zz	HI7630-48zz
Ø 50 mm (2")	BL120-550	<input checked="" type="checkbox"/>	<input type="checkbox"/>
Ø 63 mm (2½")	BL120-563	<input checked="" type="checkbox"/>	<input type="checkbox"/>
Ø 75 mm (3")	BL120-575	<input checked="" type="checkbox"/>	<input type="checkbox"/>

22.2.4. Installation Tee

- Install the probe in a tee, horizontally, and direct the flow into the opening at the bottom of the probe.
- Upward flow direction must always be ensured.
- Maintain a stable flow rate to minimize interferences from bubbles and settling of particulates.
- Wrap PTFE tape around the probe's threads and fittings before mounting.

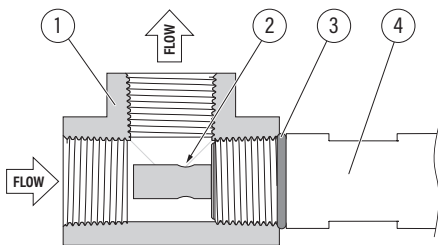

1	Tee 3/4" NPT
2	Vent hole
3	O-ring
4	Probe

22.2.5. Tank Immersion with Submersible Electrode Holder

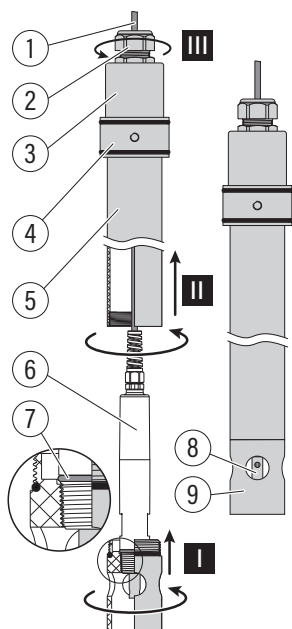

1	Probe cable
2	Cable gland
3	Electrode holder cap
4	Adjustable immersion level
5	Electrode holder
6	Probe body
7	O-ring, Ø 22.2 mm (0.87")
8	Sensor tip
9	Protective end cap

The [HI60501/HI60503](#) (PVC/PVDF submersible holders) together with [HI60501-2](#) or [HI60503-2](#) (PVC/PVDF protective end caps), and [HI605011](#) (mounting flange) provide a sturdy housing that prevents the probe from being damaged. For high-temperature/complex chemical processes it is recommended the use of PVDF accessories. To install the probe:

- A. Unscrew the protective end cap (9).
The cap allows for quick and simple probe maintenance and replacement.
- B. Slide out the holder cap (3).
- C. Screw the probe into the internally threaded protective cap (9), step I.
- D. Screw the probe and protective cap subassembly onto the holder (5), step II.
- E. Feed the probe cable through the holder (5) and out through the cap (3) and cable gland on top (2).
The cable is shielded inside the holder to prevent any damage to the insulation.
- F. Tighten the cable gland (2), step III, and slide the cap (3) back onto the electrode holder (5).

22.2.6. Flow-cell Installation

- Position and orient the probe so that it does not trap air bubbles at the sensing area.
- Do not allow deposits of sediment or other foreign material to accumulate within the sensing area.

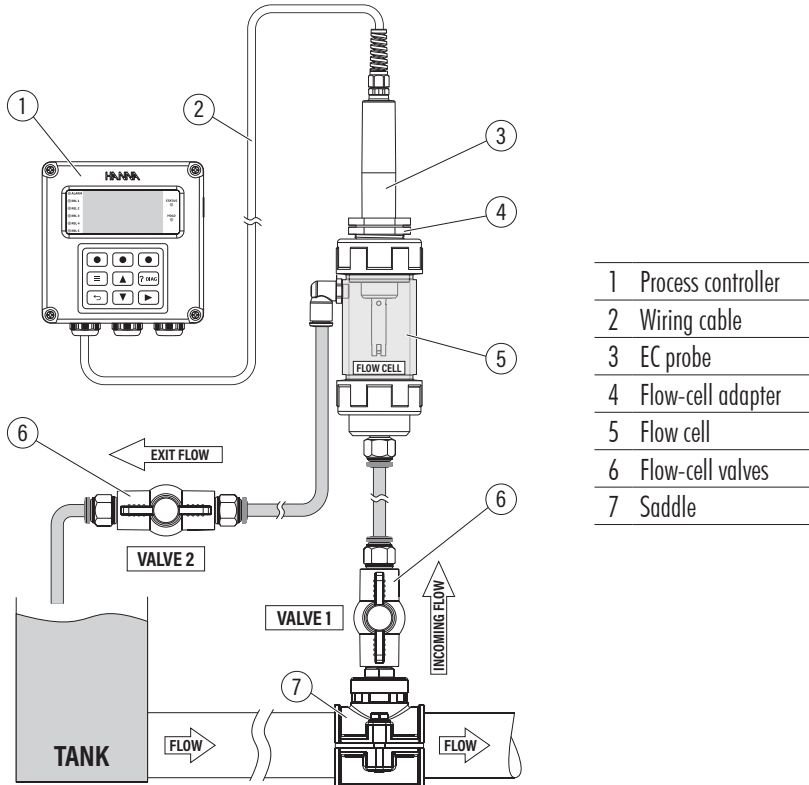

22.3. CONFIGURABLE MEASUREMENT PARAMETERS

Measurement Mode (Meas.Mode)

Option: EC, TDS, RES, Sal %, Sal ppt, Sal psu

TDS

A calculated value based on the conductivity of the solution ($TDS = \text{factor} \times EC_{25}$). A TDS factor is a conversion factor used to change an EC measurement to a ppm measurement. Typical TDS factor for strong ionic solutions is 0.50 (based upon a sodium chloride), while for weak ionic solutions is 0.70 (based upon potassium chloride).

Sal psu

The practical salinity of seawater relates the ratio of electrical conductivity of a normal seawater sample at 15 °C and 1 atmosphere to a potassium chloride solution (KCl) with a mass of 32.4356 g/Kg water at the same temperature and pressure. Under these conditions the ratio is equal to 1 and $S=35$. The practical salinity scale may be applied to values 0 through 42.00 psu at temperatures between 0 to 35 °C.

Sal ppt

Measurements expressed in **ppt** are based on the Natural Seawater Scale that extends from 0.00 to 80.00 g/L and covers 10 to 31 °C temperature range. It determines the salinity based upon a conductivity ratio of sample to standard seawater at 15 °C and an approximate salinity value of 35 in seawater.

Sal %

In this scale 100 % salinity is equivalent to roughly 10 % solids.

- With item selected, press **Modify** for the drop-down options list.
- Use the **▲** **▼** keys to scroll between options
- Press **Select** to save.

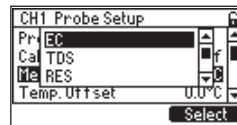
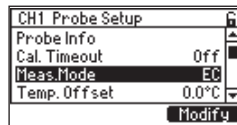

Temperature Compensation (Temp.Comp.)

Option: Linear, Natural, Standard, None

Note: When Meas.Mode is set to Sal %, Sal psu, or Sal ppt, Linear is the only available option.

An integral **temperature sensor** measures the process temperature and adjusts the measured conductivity to a reference temperature by applying specialized compensation standards:

- **Linear:** appropriate when it is assumed that the temperature coefficient of variation has the same value for all measurement temperatures
- **Standard:** appropriate for high-purity water measurements and documented in ASTM Standard D5391-14. This setting should be used for resistivity measurements.
- **Natural:** appropriate for natural ground, well, or surface water (or water with similar composition) in accordance with ISO7888 standard.

The result is reliable electrolytic conductivity (EC), TDS (Total Dissolved Solids), resistivity, or Seawater Salinity in percent, psu, or ppt units.

- With item selected, press **Modify** for the drop-down options list.
- Press the **▲** **▼** keys to scroll between options.
- Press **Select** to save.

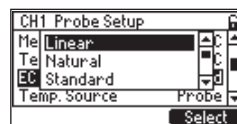
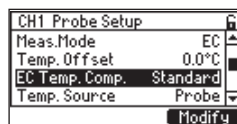

Temperature Source (Temp. Source)

Option: Probe, Manual

- With item selected, press **Modify** for the drop-down options list.
- Use the **▲** **▼** keys to scroll between options.

- Press **Select** to save.

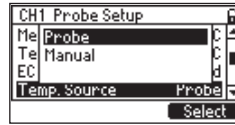
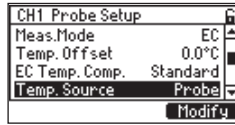

Manual Temperature Value (Man. Temp. Value)

Default value is 25 °C.

- With item selected, press **Set** to modify the value.
- Use the **▲** **▼** keys to modify the flashing value, down to minimum or up to maximum probe limits (-20 to 120 °C/68 to 248 °F).
- Press **CFM** to save.

This temperature is used when Temp. Source is set to Manual.

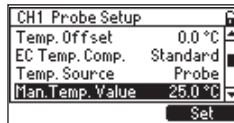

Reference Temperature (Ref.Temp.[°C])

Option: 15.0 °C to 25.0 °C

This value is used for temperature compensated conductivity. All EC measurements will be referenced to the conductivity of a sample at this temperature.

- With item selected, press **Set** to modify.
The flashing value indicates that it can be modified by using the **▲** **▼** keys.
- Press **CFM** to save.

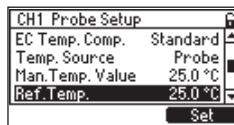

Temperature Coefficient (Temp.Coeff[%/°C])

Option: 0.00 to 10.00 %/°C

Temperature coefficient is a function of the solution being measured. For freshwater samples, the temperature coefficient is approximately 1.90 %/°C.

- With item selected, press **Set** to modify. The flashing value indicates that it can be modified by using the **▲** **▼** keys.
- Press **CFM** to save.

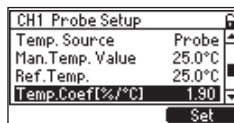

TDS Factor

Option: 0.00 to 1.00

- With item selected, press **Set** to modify. The flashing value indicates that it can be modified by using the   keys.
- Press **CFM** to save.

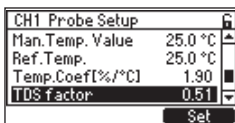

Measurement Unit

Option: μS (EC), mg/L or ppm (TDS), Ω (RES), Sal% (Sal%), Salppt (Sal ppt), Salpsu (Sal psu)

With Meas.Mode set to **TDS**, use the virtual key to toggle between options.

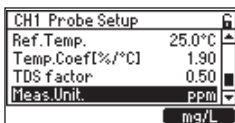





22.4. CALIBRATION

HI520 controller allows two types of EC calibration procedures:

- **Standard** two-point **conductivity** calibration with standards for cell factor determination :
 - ▶ 0.000 $\mu\text{S}/\text{cm}$ for **offset**
 - ▶ 84.0 $\mu\text{S}/\text{cm}$, 1413 $\mu\text{S}/\text{cm}$, 5.00 mS/cm , 12.88 mS/cm for the **0.1/cm** cell
 - ▶ 80.0 mS/cm , 111.8 mS/cm additional standards for the **1.0/cm** cell
- **Standard** single point **salinity** calibration in 100 % salinity standard, with the controller set to Sal % measurement mode after the EC range has been calibrated
- **Process** single point calibration performed with calibrated probes installed in the process

Note: EC measurement mode (Meas.Mode) supports a one-point calibration with a known conductivity solution that is not temperature compensated.

- With Mode selected, go to Probe Setup, press the   keys to select Temp. Comp.
- With parameter highlighted, press **Modify** for the drop-down options list.
- Press the   directional keys to select **None**.

22.4.1. Standard Conductivity (EC) Calibration

Preparation

- Always clean the probe in distilled water, shake off water droplets, and allow to dry prior to calibration.
- Suspend the probe in the air and use 0.000 $\mu\text{S}/\text{cm}$ as first calibration point.
- Inspect the probe for debris or blockages.
- Use an EC calibration standard with a value that is close to that of the sample.
- Ensure that probe’s holes are completely submerged.

- Tap the probe repeatedly to remove any air bubbles that may be trapped inside the sleeve.
- To minimize cross-contamination, when a two-point calibration is required, use two beakers: one for rinsing the probe and the other for calibration.
- Go to Probe Settings in Channel Setup and set Meas. Mode to EC.

Procedure

One-Point

1. Press **CAL** to enter calibration mode.
2. At prompt, with the password enabled, input the passcode.
3. Suspend the probe in the air. Allow for the reading to stabilize.
4. Press **CLR** to delete a previous calibration, or **Process** to enter process calibration.
5. When the reading is stable and within the limits, **CFM** is displayed. Press **CFM** to save.

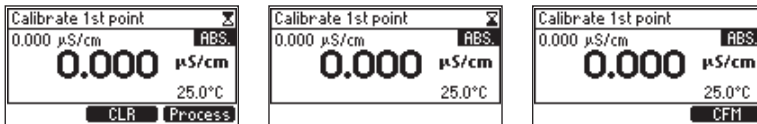

“Wait” is displayed at until the first calibration point (Offset calibration) is accepted and saved.

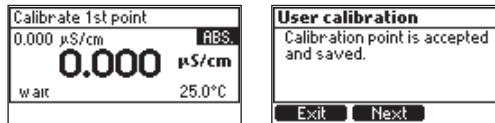

6. Press **Next**, to continue with a second point (or **Exit** to return to the menu).

Two-Point

7. Raise and lower conductivity cell in rinse beaker of standard, then discard.
8. Immerse the sensor in EC standard. The controller will automatically recognize the standard. Allow the reading to stabilize.
9. Press **CFM** when displayed to confirm the second point and save the calibration.

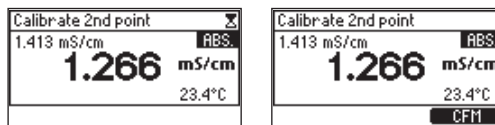

“Wait” followed by the “Calibration DONE” confirmation screen notifies the user that the two-point calibration is complete. The controller returns to the menu.

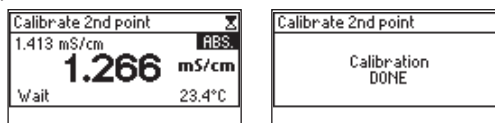

22.4.2. Process Calibration

A process calibration is a single point calibration performed with the probe installed in the process. This type of calibration allows the user to adjust the measured EC or Seawater salinity value so that it matches the value determined with a calibrated reference meter.

Preparation

Use a reference instrument to determine the process EC or Salinity value and write down the value.

- Go to Channel Menu item, press **Setup** virtual key and select Probe Settings.
- Press **Setup** again and use the **▲** **▼** keys to navigate to Meas.Mode item.
- If not configured, press **Modify** to set EC mode.

Procedure

1. Press **CAL** to enter calibration mode.
2. At prompt, with the password enabled, input the passcode.
3. Press **Process** when displayed to enter calibration.

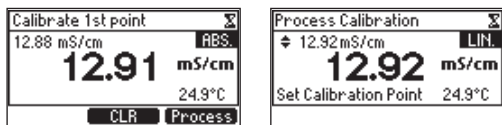

4. Press the **▲** **▼** directional keys to adjust the process value in agreement with the predetermined value.
5. When the reading is stable, **CFM** is displayed. Press **CFM** to save.

“Wait” is displayed followed by “DONE” when the process calibration is confirmed and saved.

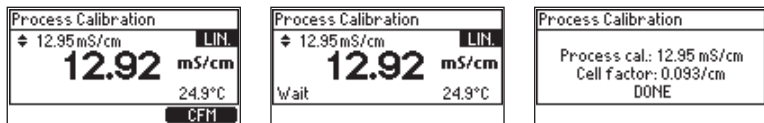

Note: For process calibration, input reading must be greater than 0.1 $\mu\text{S}/\text{cm}$ and Setpoint value should not be lower than 0.065 $\mu\text{S}/\text{cm}$.

22.4.3. Salinity Calibration (HI7630-48zz series only)

Salinity calibration can be performed with the controller set to Sal % measurement mode after the EC range has been calibrated.

Procedure

1. Press **CAL** to enter calibration mode.
2. At prompt, with the password enabled, input the passcode.
3. Raise and lower conductivity cell in rinse beaker of salinity standard then discard.
4. Immerse the sensor in salinity standard. The controller automatically recognizes the standard. Allow the reading to stabilize.

5. Press CFM when displayed to confirm and save the calibration.

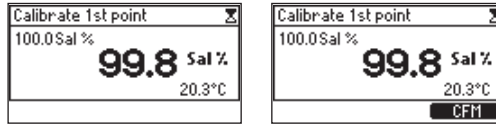

“Wait” is displayed followed by “Calibration DONE” when the process calibration is confirmed and saved. The controller returns to the menu.

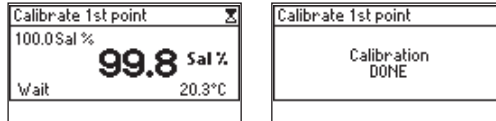

22.4.4. Measurements in ultrapure water

Resistivity is the reciprocal of conductivity and their scales emphasize different areas of the measurement range. Resistivity is commonly used in ultrapure water while larger amounts of contaminants are best measured in conductivity (EC) Meas.Mode. The user can subsequently change Meas.Mode to RES to measure in resistivity units ($M\Omega \cdot cm$).

Ultrapure water self ionizes into H^+ and OH^- ions and has a **conductivity** of $0.055 \mu S/cm$ or a **resistivity** of $18.18 M\Omega \cdot cm$ at $25^\circ C$. The self-ionization of water is highly temperature dependent.

Recommended temperature compensation setting for these type of measurements taken with HI7630-28 probes only is “Standard” as it utilizes the correct compensation algorithm.

Calibration recommendations

- Remove the probe from the process and shake all the water from the probe.
- Wait for moisture to evaporate off the probe before calibration.
- Suspend the probe in the air and use $0.000 \mu S/cm$ or $0.0 \mu S/cm$ as first calibration point.
- Use $84 \mu S/cm$ standard for the best calibration.

Process calibration (with conductivity calibration completed only)



To enter resistivity process calibration, the resistivity input value should be greater than $50 \Omega \cdot cm$ ($k \approx 0.1/cm$) or $15 \Omega \cdot cm$ ($k \approx 1.0/cm$).

1. Place the cleaned probe in line, in a flowing, gas-free water.
2. Allow the probe to acclimate to the water and temperature of the water.
3. Return the Meas.Mode back to RES.
4. Verify Temp.Comp. is set to **Standard**.
Verify temperature agrees with the reference measurement.
5. Use Temp. Offset to adjust temperature.

The cell may be calibrated using a reference measuring system on site or a traceable plant standard.

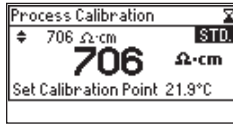
- Press  direct key then **CAL** virtual key.



- Use   directional keys to adjust the process value in agreement with the standard value.
- Press **CFM** when displayed to confirm and save calibration.

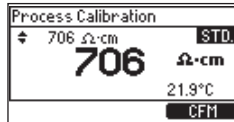

“Wait” is displayed followed by “DONE” when the process calibration is confirmed and saved. The controller returns to the menu.

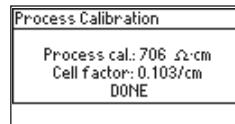
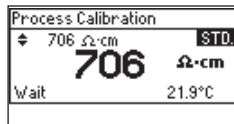

Installation recommendations

The **HI520** controller together with a **HI7630-28zz** probe is designed to meet the ASTM D5391-99 requirements for electrical conductivity and resistivity of flowing high-purity water samples.

- The installation must exclude air contact with the sample.
- Install the probe in a tee, horizontally, and direct the flow into the opening at the bottom of the probe. Alternatively, the probe can be installed in a flow-cell.
- Maintain a steady flow rate to minimize interferences from bubbles, settling of particulates, and provide a faster response.
- The probe is specified up to 6 bar @25 °C.

22.4.5. Clear Calibration

- From calibration screen, press **CLR** when displayed.
- Press **Yes** to confirm deletion.
- “Calibration Erased” confirmation screen is displayed and then the controller reenters calibration mode.

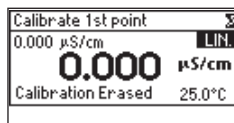
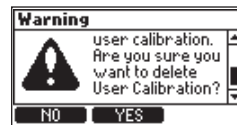
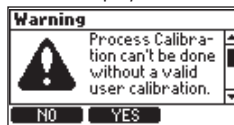
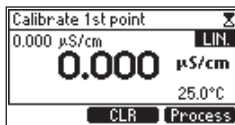

- Press the  (back) key to return to the menu.

Calibration Messages & Warnings

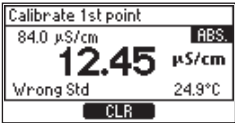
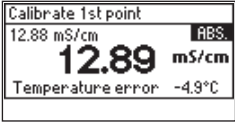
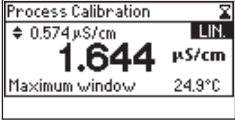
Message & Description	Recommended Action
 <p>Calibrate 1st point 84.0 $\mu\text{S}/\text{cm}$ ABS 12.45 $\mu\text{S}/\text{cm}$ Wrong Std 24.9°C CLR</p>	<p>"Wrong Std" The reading exceeds the expected value. Calibration can not be confirmed.</p> <p>Check that correct calibration solution has been used and / or clean the probe.</p>
 <p>Calibrate 1st point 12.88 mS/cm ABS 12.89 mS/cm Temperature error -4.9°C</p>	<p>"Temperature Error" The temperature of the solution is out of temperature compensation interval.</p> <p>Use fresh calibration solution and / or clean the temperature sensor.</p>
 <p>Process Calibration 0.574 $\mu\text{S}/\text{cm}$ LIN 1.644 $\mu\text{S}/\text{cm}$ Maximum window 24.9°C</p>	<p>"Maximum window" During a process calibration, the calibration value exceeds upper boundary value.</p> <p>Change calibration point value, clear calibration or exit by pressing the back key.</p>

22.5. MAINTENANCE

- Clean the probe regularly to prevent debris buildup between rings or blockage of the vent hole (four-ring probes).
- Rinse the probe thoroughly as water residue may not be visible.
- Inspect all sensor connectors for corrosion and replace if necessary.

Cleaning

Dirty or improperly cleaned probes can result in erratic and inaccurate readings.

- Remove and inspect the probe during scheduled service intervals.
- Dry clean the sensor with a soft bristle brush to loosen any debris.

For a more thorough cleaning:

- Use a cloth and warm water with a soapy surfactant to clean and follow with a thorough rinse with purified (deionized) water. Ensure that the holes and cell channel in the sensor are free of foreign material.
- Flush with purified water after cleaning.

Four-ring probe cleaning

- Remove and inspect the probe during scheduled service intervals.
- Clean off the external sheath with a soft cloth and surfactant solution.
- Rinse the probe under a stream of running tap water to remove salt or minerals.
- Jet the tap water stream through the opening to dislodge any debris.
- If strictly necessary, carefully remove the outer plastic sheath to disassemble the probe.
Clean with a warm water/surfactant mixture and follow with a through rinsing with purified water.
Allow pieces to dry and reassemble.

Storage

- EC probes should always be stored dry after cleaning in distilled water.
- After long-term storage or cleaning, calibration is required.

23. MEASURING WITH GALVANIC DISSOLVED OXYGEN (DO) PROBES

23.1. PROBE PREPARATION & CONDITIONING

- Probes from Hanna Instruments® are shipped dry.
- Remove the red and black shipping cap before use.
- The membrane cap and the electrolyte reservoir need to be filled with **H17042B** galvanic DO electrolyte solution prior to the first use.

See section **23.6.2 Membrane Cap & Electrolyte Replacement** recommendations.

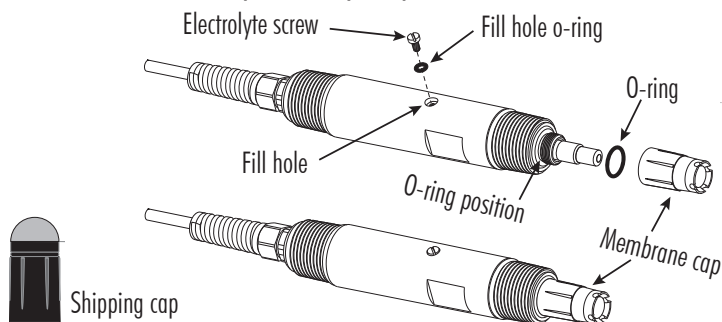

Electrolyte (re)filling Procedure

1. Unscrew and remove the electrolyte screw and O-ring located on the side of probe body (see figure). Set aside.
2. Open the membrane package and remove one O-ring and one membrane cap.
3. Slide the O-ring onto the anode and over the cap's threads to rest flush against the probe body.
4. Rinse the new membrane cap with some electrolyte and discard.
5. Attach supplied (with probe, probes sold separately) cone-shaped tip to the syringe.
6. Draw up a full syringe by pulling back on the plunger.
7. Dispense some of the electrolyte to fill half of the membrane cap with solution.
8. Tap the cap to release any trapped air bubbles. Allow bubbles to rise to the surface.
9. Point the probe downwards and screw on the cap, forcing electrolyte into reservoir and allowing remaining trapped air to escape through the electrolyte screw hole. Tighten the membrane cap so that it sits flush with the probe body.
10. Hold the probe sideways (slightly downwards) and use the syringe to fill up the reservoir with remaining amount of electrolyte solution. Draw and then dispense more liquid until excess electrolyte flows out allowing trapped air to escape. The probe holds approximately 7 mL of electrolyte.
11. Replace the fill hole O-ring and tighten the screw in position.
12. Firmly tap the probe sides to ensure no trapped bubbles inside the cap.
13. Keep the probe in water for a few hours to acclimate.
14. Calibrate before installation.

23.2. GENERAL INSTALLATION CONSIDERATIONS

- Probes are easily installed using the 3/4" NPT external threads.
- Do not install the probe in an upside-down position.
- Hand tighten the probe in position. Then, depending on the process, tighten one or two turns with a wrench to secure in place. Do not exceed the 10 N•m (7.3 lb-ft) torque specification for the probe sensor.
- The sensor consumes oxygen. Ensure an adequate water movement of around 0.03 m/sec. past the sensing area, regardless of installation type, to avoid local depletion of oxygen and erroneously low readings.
- The membrane should stay wetted to prevent water vapor crossing the membrane and depleting electrolyte.
- Protect the probe and membrane from strong flow to prevent unstable readings. In turbulent aeration basin installations, place the probe in a weir for more accurate readings.
- Protected the membrane from blunt objects.
- Keep the membrane clean to allow free exchange of oxygen.
- Avoid fast flow rates (risk of cavitation) and slow flow rates (risk of oxygen depletion).
- Provisions must be made for the removal of the probe from the process.
- Consider probe accessibility for maintenance when selecting placement.

Note: See galvanic DO industrial probes manual (MAN7640-18) for series configuration options and detailed specifications.

23.3. INSTALLATION SCHEMES & MOUNTING ACCESSORIES

Accessories are sold separately!

23.3.1. Probe dimensions

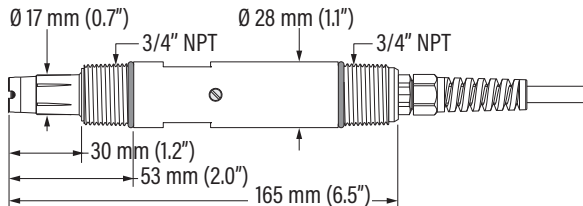

Figure 68: HI7640-18zz galvanic DO probe with attached cable

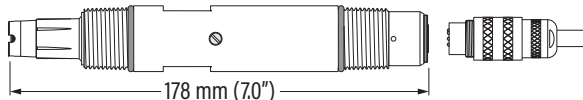
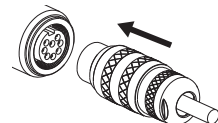

Figure 69: HI7640-1800 galvanic DO probe with DIN connector

23.3.2. Probe Connection

Align the pins and key, then push the plug into the socket.

Rotate the collar to lock in place.



*Note: Probe connection (probe with integral DIN connector) and probe wiring (probe with attached cable) **must be** carried out with the controller **disconnected** from power.*

23.3.3. In-line Mounting with Probe Saddle

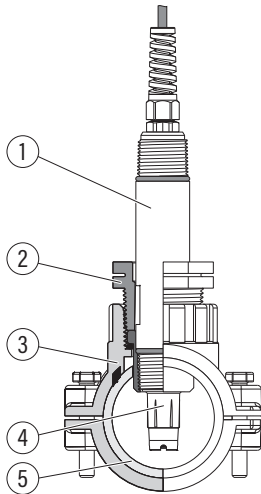

- | | |
|---|-------------------|
| 1 | Probe |
| 2 | Probe fitting kit |
| 3 | Saddle |
| 4 | Membrane cap |
| 5 | Pipe |

Mounting accessories

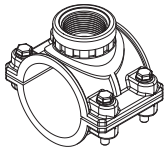

Pipe size	Saddle code	HI7640-18zz
Ø 50 mm (2")	BL120-550	<input checked="" type="checkbox"/>
Ø 63 mm (2½")	BL120-563	<input checked="" type="checkbox"/>
Ø 75 mm (3")	BL120-575	<input checked="" type="checkbox"/>

23.3.4. Top thread immersion, user assembled

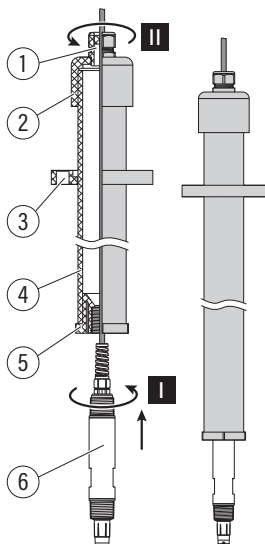

- | | |
|---|--|
| 1 | Cable gland |
| 2 | Pipe cap (socket connect or threaded) |
| 3 | Van Stone flange (one size smaller than the pipe) |
| 4 | 2", or similar, PVC pipe (schedule 80 PVC)
Reducer bushing |
| 5 | <ul style="list-style-type: none"> • internal threads to fit probe's ¾" NPT threads • external threads to fit pipe or socket-connect |
| 6 | Galvanic DO probe |

- A. Wrap PTFE tape around the probe's (6) top 3/4" NPT threads.
- B. Attach a user-supplied reducer bushing (5) to the probe's (6) top threads (step I).
- C. Feed probe cable through length of NPT externally threaded, user supplied pipe (4), matched to reducer.
- D. Thread the pipe into the upper threads of the reducer (5).
- E. Seal the top part of the pipe (step II) to prevent ingress of water if installation is outdoor.
- F. Attach the pipe to a handrail.

Note: Use a bracket or a user-supplied elbow-threaded fitting (to the pipe) to orient the probe such that the membrane cap is facing the incoming flow.

23.3.5. Flow-cell installation

- Position the probe so that it does not trap air bubbles at the membrane cap.
- Adjust the flow rate to around 150 L/hour (40 gallon/hour) to provide the DO sensor with the required water movement.
- The circulation pipes (from the tank to the flow-cell) must be thermally insulated. Avoid temperature differences greater than 2 °C (36 °F) between tank content and flow-cell sample.
- Shade the assembly from direct sunlight.
- Do not allow deposits to accumulate within membrane area.

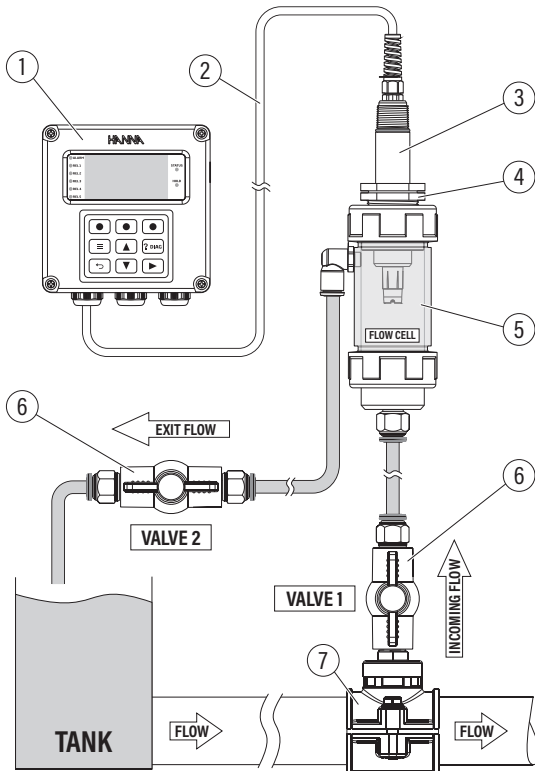

1	Process controller
2	Wiring cable
3	DO probe
4	Flow-cell adapter
5	Flow cell
6	Flow-cell valves
7	Saddle

23.3.6. Installation tee, user supplied

- Orient the probe with the sensor facing the flow.
- Wrap PTFE tape around the probe's top threads and fittings before mounting.

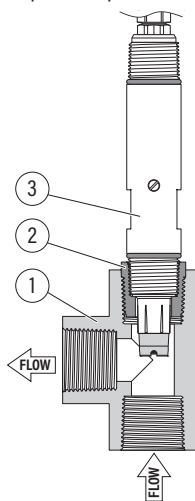

- 1 Tee
- 2 Adapter
- 3 Probe

Mounting accessories

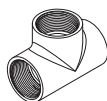

TEE fitting size	Adapter size
1"	from 1" to 3/4" NPT
1 1/4"	from 1 1/4" to 3/4" NPT
1 1/2"	from 1 1/2" to 3/4" NPT
2"	from 2" to 3/4" NPT

23.4. CONFIGURABLE MEASUREMENT PARAMETERS

Temperature Source (Temp. Source)

Option: Probe, Manual

- With item selected, press **Modify** for the drop-down options list.
- Use the **▲** **▼** keys to scroll between Probe or Manual.
- Press **Select** to save.

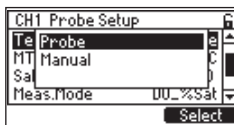
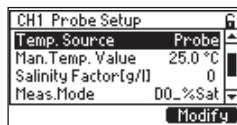

Manual Temperature (Man. Temp.) Value

Default value is 25 °C

- With item selected, press **Set** to modify the value.
- Use the **▲** **▼** keys to modify the flashing value.
- Press **CFM**, to save.

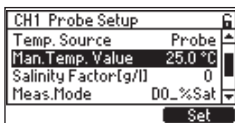

Temp. Source has to be set as Manual.



Salinity Factor[g/l]

Option: 0 to 70 g/L

The salinity correction factor is the ratio of the solubility of oxygen in water at a particular salinity to its solubility in fresh water at an identically specified water temperature and barometric pressure.



- With item selected press **Set**.
- Use the   keys to modify the flashing value.
- Press **CFM** to save the value.

CH1 Probe Setup	
Temp. Source	Probe
Man.Temp. Value	25.0 °C
Salinity Factor[g/l]	0
Meas.Mode	DO_%Sat
Set	

Measurement Mode (Meas.Mode)

Option: DO_%Sat, DO_Conc

Allows users to select between measuring DO saturation and DO concentration.

- With item selected, press **Modify** for the drop-down options list.
- Use the   keys to scroll between options.
- Press **Select** to save.

CH1 Probe Setup	
Man.Temp. Value	25.0 °C
Salinity Factor[g/l]	0
Meas.Mode	DO_%Sat
Meas.Unit	%Sat
Modify	

CH1 Probe Setup	
Ma	DO_%Sat
Sal	DO_Conc
Me	%Sat
Meas.Unit	%Sat
Select	

Measurement Unit (Meas.Mode)

Option: mg/L or ppm (with Meas.Mode set to DO_Conc)

Note: With Meas.Mode set to DO_%Sat, measurements are displayed in %Sat.

CH1 Probe Setup	
Salinity Factor[g/l]	0
Meas.Mode	DO_Conc
Meas.Unit	ppm
Averaging Samples #	1
mg/L	

CH1 Probe Setup	
Salinity Factor[g/l]	0
Meas.Mode	DO_%Sat
Meas.Unit	%Sat
Averaging Samples #	1

Averaging Samples

Option: 1 to 60

Average sampling is a software filter to minimize sensor noise and provide more stable readings. Allows users to get a representative reading of the “average” value from flowing water.

Averaging affects measurement. If a fast response is needed, this value should be kept low.

- With item selected, press **Set**.
- Use the   keys to modify the number of samples to average.

- Press **CFM** to save.

CH1 Probe Setup	
Salinity Factor(g/l)	0
Meas.Mode	DO_ %Sat
Meas.Unit	%Sat
Averaging Samples #	1
Set	

CH1 Probe Setup	
Salinity Factor(g/l)	0
Meas.Mode	DO_ %Sat
Meas.Unit	%Sat
Averaging Samples #	60
CFM	

Salinity Source

Option: Setup, Probe

Selects the source for salinity compensation.

- With Salinity Source selected, press **Setup** to use the Salinity Factor value.
- With Salinity Source selected, press **Probe** to use the salinity value from a connected EC probe.

CH2 Probe Setup	
Meas.Mode	DO_ %Sat
Meas.Unit	%Sat
Averaging Samples #	1
Salinity Source	Setup
Probe	

CH2 Probe Setup	
Meas.Mode	DO_ %Sat
Meas.Unit	%Sat
Averaging Samples #	1
Salinity Source	Probe
Setup	

23.5. CALIBRATION

HI520 controller allows two types of dissolved oxygen calibration procedures:

- **Standard** single or two-points calibration using water-saturated air or air-saturated water and a zero oxygen solution to verify that the probe is working correctly and establish a slope
- **Process** single-point calibration performed with the calibrated probe (two points) installed in the process. Process calibration allows the user to adjust the measured dissolved oxygen value to match the value determined with a reference device.

Notes: See 6.1 **Probe Settings Navigation for Temp. Offset & Temperature Calibration Procedure** section. To calibrate the internal pressure sensor, see **Pressure Calibration in 13 Technical Menu** section.

23.5.1. User Calibration at 100 % and % Saturation

Preparation

- Ensure (visual inspection) no bubbles are trapped between the cathode and membrane, and the probe is correctly wired and connected to the controller.
- Verify the temperature is reading correctly. The temperature value can be adjusted from the controller's Probe Setting menu, in Channel Setup.
- Verify the controller's barometric pressure reading with a reference meter. Pressure value can be adjusted from the controller's Technical Menu.
- Go to Probe Setting in Channel Setup to set measurement mode (Meas.Mode) and measurement unit (Meas.Unit). Select between:
 - ▶ DO_ %Sat (% saturation) with unit displayed in %Sat
 - ▶ DO_ Conc (Concentration) with unit displayed in mg/L or ppm
- Set the Salinity value if the probe will be exposed to ocean or brackish waters.

Procedure

A two-point calibration uses water-saturated air and zero oxygen solution to calibrate.

1. Press **CAL** to enter calibration mode.
2. At prompt, with the password enabled, input the passcode.
The controller recognizes the currently selected measurement unit.
3. To calibrate at 100 % saturation (or 8.26 mg/L) suspend the probe in air above a water surface and wait at least 15 minutes for the air to become saturated with water vapor.
4. Press **CAL**.
5. Press **CFM** when displayed (once the reading has stabilized) followed by **Next**.

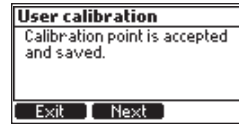
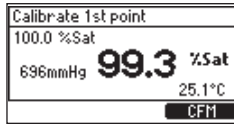
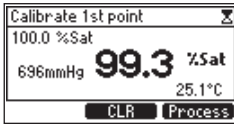

6. Submerge the probe into **HI7040** Zero oxygen solution and stir gently for 2-3 minutes.
Wait for the temperature and probe values to become stable.
The controller automatically recognizes the 0 % (ppm) standard and the value is displayed.
7. When the reading is stable **CFM** is displayed. Press **CFM** to save.

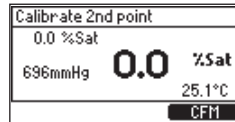
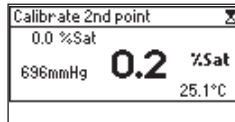

“Wait” is displayed at the bottom of the LCD until the calibration is saved.

“Calibration DONE” message is displayed and the controller returns to the menu.

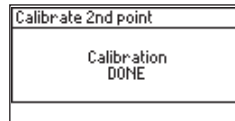
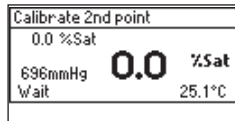

23.5.2. Process Calibration

A process calibration is a single-point calibration performed with the probe installed in the process. This type of calibration allows the user to adjust the measured DO value to match the value determined with the reference meter.

Preparation

- Determine process DO value using a calibrated reference meter and probe.
- The process controller and the probe should have previously been calibrated with two standards (probe slope determined).

Procedure

1. Press **CAL** to enter calibration mode.
At prompt, with the password enabled, input the passcode.

2. Press **Process** to enter process calibration.

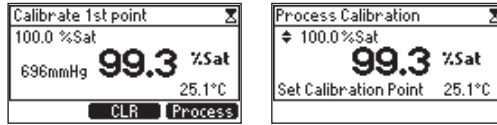

3. Use the **▲** **▼** directional keys to adjust the process value in agreement with the predetermined value.
4. When the reading is stable, **CFM** is displayed. Press **CFM** to save the calibration.
 "Wait" is displayed at the bottom of the LCD until the calibration is saved.
 "DONE" message screen is displayed and the controller returns to the menu.

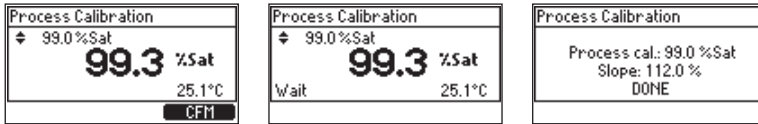

Note: Process calibration evaluates probe offset if input is reading is less than 20 %, or probe slope, if values are over 20 %.

23.5.3. Clear Calibration

1. Press **CAL** to enter calibration mode.
2. **CLR** option is displayed for a few seconds.
3. Press **CLR** to clear previous calibration.
4. Press **YES** to confirm deletion. "Calibration Erased" message screen is displayed for a few seconds then the controller returns to user calibration mode.

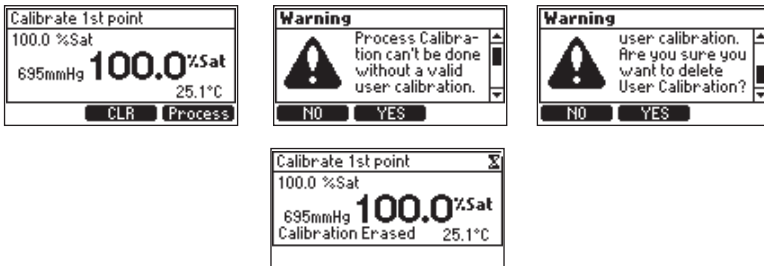

5. Press the **⏪** (back) key to return to the menu.

Calibration Messages & Warnings

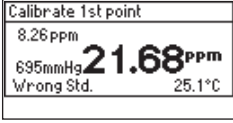
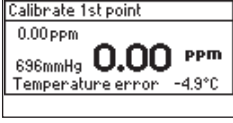
Message & Description	Recommended Action
 <p>"Wrong Std" The reading exceeds the expected value. Calibration can not be confirmed.</p>	Check that correct calibration solution has been used and / or clean the probe.
 <p>"Temperature Error" The temperature of the solution is out of temperature compensation interval.</p>	Use fresh calibration solution and/or clean the temperature sensor.

23.6. MAINTENANCE

23.6.1. Probe & Cap Membrane Cleaning

- Inspect, clean, and calibrate the probe at regular intervals.
- With the membrane cap assembled, rinse the probe with clean water. Blot the probe with a soft cloth or tissue. Handle the probe and membrane carefully to avoid damage.
- Mechanical cleaning of the membrane with abrasives is not recommended.
- Wipe probe's exterior with an aqueous soapy mixture. Gently rub persistent spots off. Rinse with clean water.
- Replace the membrane cap and electrolyte if coatings persists or membrane damage is evident.

23.6.2. Membrane Cap & Electrolyte Replacement

The membrane cap and electrolyte are designed to provide trouble-free operation for about eight weeks. Replacements are required when:

- The membrane cap is physically damaged
- Probe response is slow
- DO probe calibration or readings exhibit greater than normal drift
- The membrane cap remains coated after cleaning

Procedure

1. Remove the probe from installation.
2. Unscrew and remove electrolyte screw and fill hole O-ring located on the side of the probe body.
3. Hold the probe in a vertical position (sensing tip down) and unscrew the membrane cap. Discard used cap.
4. Remove the O-ring off probe body and shake the probe down to empty the electrolyte reservoir.
5. Flush the probe body and reservoir with tap water.
6. Ensure the channel to the electrolyte reservoir is not clogged.
7. Gently clean the deposits off the zinc anode using a lint-free cloth or tissue.
8. Inspect O-rings for nicks or wear. Replace and discard damaged O-ring.
9. If tarnished or stained, gently clean the silver cathode with a lint-free cloth.

23.6.3. Long Term Storage

Discard any electrolyte solution from the reservoir, flush probe body and reservoir with water. Blot the probe dry and store the probe with the protective cap on.

24. MEASURING WITH OPTICAL DISSOLVED OXYGEN (DO) PROBES

24.1. PROBE PREPARATION & CONDITIONING

Note: Read all the steps prior to starting probe preparation.

1. Invert the probe so the cable faces the floor.
2. Remove the protective cap.
3. Locate the O-ring that sits on probe body.

Springly lubricate with a thin film of supplied grease. Use care to prevent grease/fingerprints from contacting the optical window.

4. Remove the Smart Cap from the container.
5. Align the notched cutout arrow on the Smart Cap with the matching guide on the probe body.
6. Slide and press the Smart Cap onto the probe's body until the cap snaps in place.

Once the cap is installed, it should not be removed unless a new cap is required.
7. Place the probe in purified water for a minimum of 2 hours to hydrate the Smart Cap before use.

Notes:

If the probe is not installed immediately, place in a calibration/storage vessel with fresh water to protect it from damage and hydrate the Cap.

Prior to probe initialization, verify time and date are configured correctly in General Setup Menu.

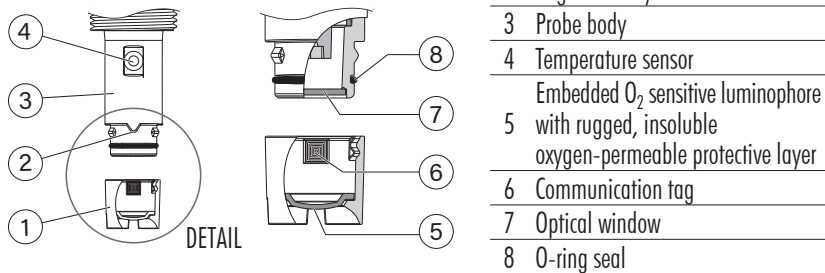

Figure 70: Smart cap detail (HI7640-58 industrial optical DO)

24.2. GENERAL INSTALLATION CONSIDERATIONS

- Probes are easily installed using the 3/4" NPT external threads.
- Hand tighten the probe in position. Then, depending on the process, tighten one or two turns with a wrench to secure in place. Do not exceed the 10 N•m (7.3 lb-ft) torque specification for the probe sensor.
- Protect the probe and the Smart Cap from strong flow to prevent unstable readings. In turbulent aeration basin installations, place the probe in a weir for more accurate readings.
- Position the probe so that it does not trap air bubbles at the Smart Cap.
- Deposits of foreign material should not be allowed to accumulate within the sensing area.
- Protect the sensing surface from blunt objects and is keep it clean.
- Provisions must be made for the removal of the probe from the process.
- Consider probe accessibility for maintenance when selecting placement.

Note: See *Optical DO industrial probes manual (MAN7640-58)* for series configuration options and detailed specifications.

24.3. INSTALLATION SCHEMES & MOUNTING ACCESSORIES

Accessories are sold separately!

24.3.1. Probe Dimensions

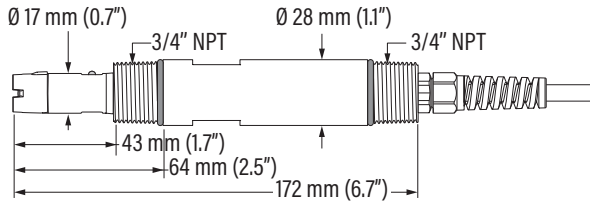

Figure 71: HI7640-58ZZ optical DO with attached cable

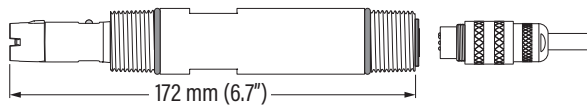
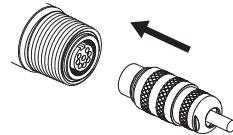

Figure 72: HI7640-5800 optical DO with DIN connector

24.3.2. Probe Connection

Align the pins and key then push the plug into the socket.
Rotate the collar to lock in place.



Note: Probe connection (probe with integral DIN connector) and probe wiring (probe with attached cable) **must be** carried out with the controller **disconnected** from power.

24.3.3. User-assembled, top thread immersion installation

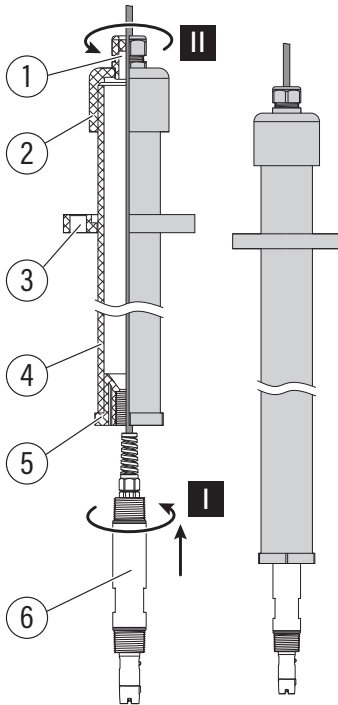

1	Cable gland
2	Pipe cap (socket connect or threaded)
3	Van Stone flange (one size smaller than the pipe)
4	2", or similar, PVC pipe (schedule 80 PVC)
	Reducer bushing
5	<ul style="list-style-type: none"> • internal thread to fit probe's $\frac{3}{4}$" NPT threads • external thread to fit pipe's threads or socket-connect type
6	Optical DO probe

- Wrap PTFE tape around the upper $\frac{3}{4}$ " NPT threads of the probe (6).
- Attach a user-supplied reducer bushing (5) to the probe (6) upper threads (step I).
- Feed the probe cable through length of NPT externally threaded, user supplied pipe (4), matched to bushing.
- Thread the pipe into the upper threads of the reducer (5) attached to the probe.
- The upper portion of the pipe should be sealed (step II) to prevent ingress of water if installation is outdoor.
- Attach the pipe to a handrail.

24.3.4. Low thread immersion installation

The **HI60501** (PVC submersible holder) together with **HI60501-2** (protective end cap), and **HI605011** (mounting flange) provide a sturdy, protective housing designed for low thread immersion installation.

24.3.5. Flow-cell installation

- The circulation pipes from the tank to the flow cell must be thermally insulated. Avoid temperature differences greater than 2 °C (36 °F) between tank content and flow cell sample.
- Shade the assembly from direct sunlight.

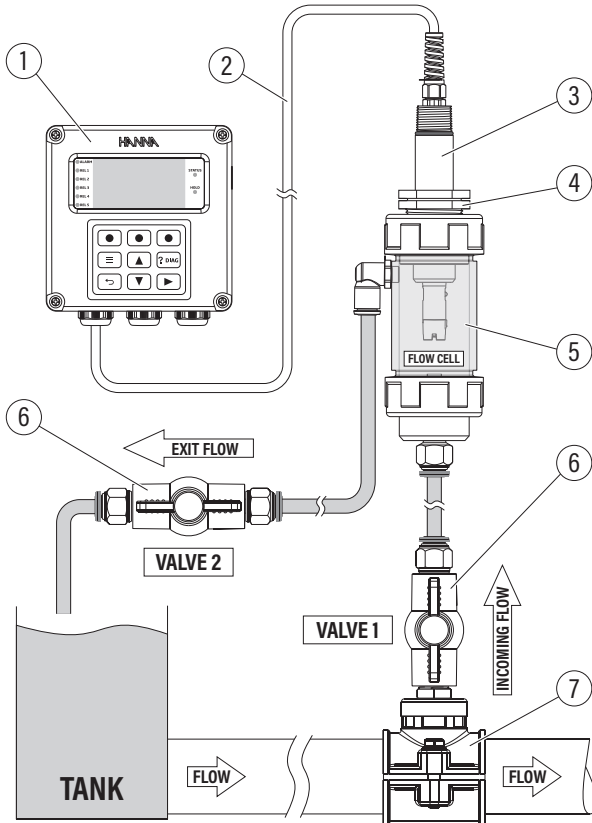

- | | |
|---|--------------------|
| 1 | Process controller |
| 2 | Wiring cable |
| 3 | Optical DO probe |
| 4 | Flow-cell adapter |
| 5 | Flow cell |
| 6 | Flow-cell valves |
| 7 | Saddle |

24.4. CONFIGURABLE MEASUREMENT PARAMETERS

Temperature Source (Temp. Source)

Option: Probe, Manual

- With item selected, press **Modify** for the drop-down options list.
- Use the **▲** **▼** keys to scroll between Probe or Manual.
- Press **Select** to save.

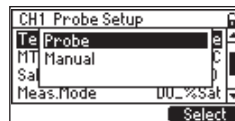
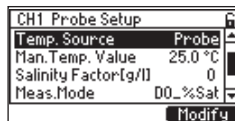

Manual Temperature (Man. Temp.) Value

Default value is 25 °C

- With item selected (and **Temp. Source** set to **Manual**), press **Set** to modify the value.
- Use the **▲** **▼** keys to modify the flashing value.
- Press **CFM**, to save.

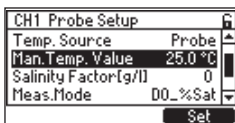

Salinity Factor [g/l]

Option: 0 to 70 g/L

The salinity correction factor is the ratio of the solubility of oxygen in water at a particular salinity to its solubility in fresh water at an identically specified water temperature and barometric pressure.

- With Salinity Factor [g/L] selected, press **Set**.
- Use the **▲** **▼** keys to modify the flashing value.
- Press **CFM** to save the value.

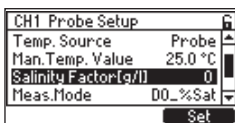

Measurement Mode (Meas.Mode)

Option: DO_%Sat, DO_Conc

Allows users to select between measuring DO saturation and DO concentration.

- With item selected, press **Modify** for the drop-down options list.
- Use the **▲** **▼** keys to scroll between options.
- Press **Select** to save.

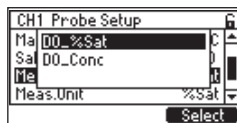
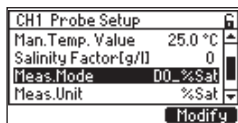

Measurement Unit (Meas. Unit)

Option: mg/L or ppm (with Meas.Mode set to DO_Conc)

Note: With Meas.Mode set to DO_%Sat, measurements are displayed in %Sat.

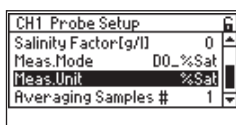
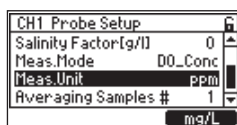

Averaging Samples

Option: 1 to 60

Average sampling is a software filter to minimize sensor noise and provide more stable readings. Allows users to get a representative reading of the “average” value from flowing water.

Averaging affects measurement. If a fast response is needed, this value should be kept low.

- With item selected, press **Set**.
- Use the **▲** **▼** keys to modify the number of samples.
- Press **CFM** to save.

CH1 Probe Setup	
Salinity Factor[g/l]	0
Meas.Mode	DO_%Sat
Meas.Unit	%Sat
Averaging Samples #	1
Set	

CH1 Probe Setup	
Salinity Factor[g/l]	0
Meas.Mode	DO_%Sat
Meas.Unit	%Sat
Averaging Samples #	60
CFM	

Salinity Source

Option: Setup, Probe

Selects the source for salinity compensation.

- With Salinity Source selected, press **Setup** to use the Salinity Factor value.
- With Salinity Source selected, press **Probe** to use the salinity value from a connected EC probe.

CH2 Probe Setup	
Meas.Mode	DO_%Sat
Meas.Unit	%Sat
Averaging Samples #	1
Salinity Source	Setup
Probe	

CH2 Probe Setup	
Meas.Mode	DO_%Sat
Meas.Unit	%Sat
Averaging Samples #	1
Salinity Source	Probe
Setup	

24.5. CALIBRATION

HI520 process controller allows two types of dissolved oxygen calibration procedures:

- **Standard** single or two-points calibration using water-saturated air or air-saturated water and a zero-oxygen solution to verify that the probe is working correctly and establish a slope
- **Process** single-point calibration performed with the calibrated probe (two points) installed in the process. Process calibration allows the user to adjust the measured DO value to match the value determined with a reference device.

Notes: See 6.1 Probe Settings Navigation for Temp. Offset & Temperature Calibration Procedure section.
To calibrate the internal pressure sensor, see Pressure Calibration in 13 Technical Menu section.

24.5.1. User Calibration at 100 % and % Saturation

Preparation

- Remove probe from process.
- Flush probe and cap with a jet of clean water.
- Inspect for scratches or voids in cap surface.
- Replace Cap as required.
- Shake any remaining solution off the probe. No droplets should remain on the DO sensing surface before performing the calibration procedure.
- Verify the controller's barometric pressure reading with a reference meter. The pressure value can be adjusted from the controller's Technical Menu.
- Verify the temperature is reading correctly. The temperature value can be adjusted from the controller's Probe Setting menu.
- Go to Probe Setting in Channel Setup to set measurement mode (Meas.Mode) and measurement unit (Meas.Unit). Select between:
 - ▶ DO_%Sat (% saturation) with unit displayed in %Sat
 - ▶ DO_Conc (Concentration) with unit displayed in mg/L or ppm
- Set the Salinity value if the probe will be exposed to ocean or brackish waters.

Procedure

1. Press **CAL** to enter calibration mode.
2. At prompt, with the password enabled, input the passcode.
3. The controller recognizes the currently selected measuring unit.
4. To calibrate at 100 % saturation (or 8.26 mg/L) suspend the probe in water-saturated air. This condition corresponds to 100 % air-saturated water at the temperature of measurement.
5. Use of calibration beaker containing some water or moistened absorbent material is recommended. Loosely screw the beaker onto the probe (first thread only).
6. Allow 15 minutes for the air inside the beaker to become water saturated.
7. Press **CAL** to enter calibration mode after this 15 minute interval has elapsed.
8. Once the reading has stabilized the **CFM** virtual key is displayed. Press **CFM** to save the calibration point.

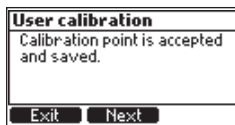
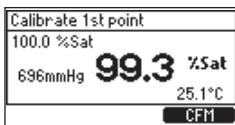
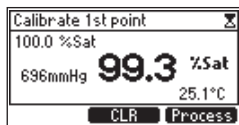

Exit and **Next** virtual keys are available. Pressing **Exit** saves a single point calibration.

9. Press **Next** to follow with second-point calibration.
10. To calibrate at 0 % (or 0 mg/L), place the probe in the **HI7040** Zero oxygen solution and stir gently for 2-3 minutes. Dislodge bubbles that may adhere to the cap. The controller automatically recognizes the 0 % (ppm) standard and the value is displayed on the LCD.

11. When the reading is stable **CFM** is displayed. Press **CFM** to save.

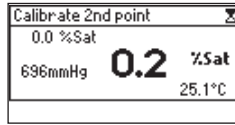

“Wait” is displayed at the bottom of the LCD until the calibration is saved.

“Calibration DONE” message is displayed and the controller returns to the menu.

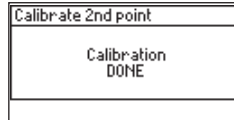
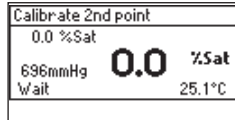

24.5.2. Process Calibration

Prior to performing a process calibration, a reference meter and probe must be used (or another method) to determine the DO value of the process.

Preparation

- Determine the process DO value, using a calibrated reference meter and probe.
- The process controller and the probe should have previously been calibrated with two standards (probe slope determined).

Procedure

1. Press **CAL** to enter calibration mode.
At prompt, with the password enabled, input the passcode.
2. Press **Process** to enter process calibration.
3. Use the **▲** **▼** keys to adjust the process value in agreement with the predetermined value.

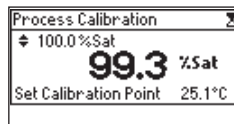
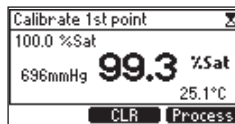

4. When the reading is stable, **CFM** is displayed. Press **CFM** to save the calibration.

“Wait” is displayed at the bottom of the LCD until the calibration is saved.

“DONE” message is displayed and the controller returns to the menu.

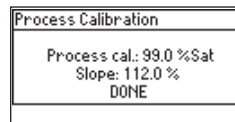
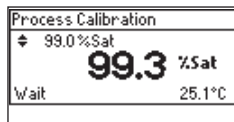
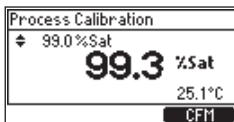

Note: Process calibration evaluates probe offset if input is reading is less than 20 %, or probe slope if values are over 20 %.

24.5.3. Clear Calibration

1. Press **CAL** to enter calibration mode.
2. **CLR** option is displayed for a few seconds.
3. Press **CLR** to clear previous calibration.
4. Press **YES** to confirm deletion. “Calibration Erased” message screen is displayed for a few seconds then the controller returns to user calibration mode.
5. Press the  (back) key to return to the menu.

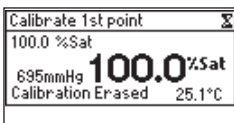
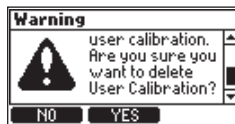
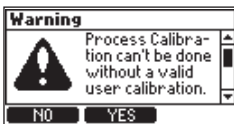
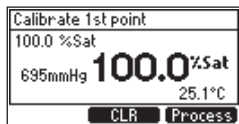

Calibration Messages & Warnings

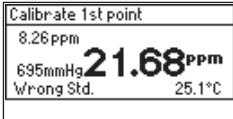
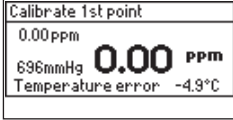
Message & Description	Recommended Action
 <p>“Wrong Std” The reading exceeds the expected value. Calibration can not be confirmed.</p>	Check that correct calibration solution has been used and / or clean the probe.
 <p>“Temperature Error” The temperature of the solution is out of temperature compensation interval.</p>	Use fresh calibration solution and / or clean the temperature sensor.

MAINTENANCE

General Maintenance

- Inspect O-ring for nicks or other damage. Replacing the o ring is advised.
- Do not substitute other grease or lubricants as it may cause the O-ring to swell.
- After long-term storage or cleaning, calibrate the probe.
- After use, rinse the probe with tap water and dry it.
- The DO cap must be kept hydrated.

Cleaning the Smart Cap

- Use a mild detergent and a soft-bristled toothbrush to clean.
- Rinse with water after cleaning and dry with a laboratory tissue.
- Hydrate in purified water before use.

Note: Smart Caps need to be replaced every year.

Smart Cap Replacement

When the cap approaches annual expiration, a warning screen notifies the user of required replacement.

Press **[? DIAG]** key to read days remaining before expiration. When one year is reached the message will change to “Cap Expired”. To maintain measurement accuracy Smart Cap replacement is mandatory.

Ensure all cap-replacement steps are correctly followed.

1. Prior to cap replacement, verify time and date are correctly set in the controller setup menu.
2. Turn OFF the controller or unplug the removable terminal connector marked PROBE by loosening the four screws and reaching inside the enclosure.
3. Clean off probe body and dry off with cloth.
4. Remove the expired Smart Cap from the probe by squeezing the cap at the cutout arrow and pulling it off the probe body (do not twist).
5. Remove the used O-ring by rolling it off the body.

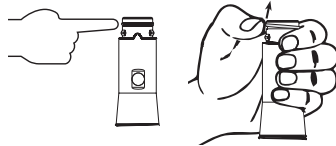
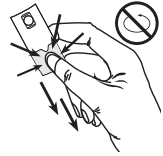

6. Clean the O-ring groove and lens with a soft tissue followed by the lens cleaning wipe.



7. Remove the new O-ring from the container and slide on the probe tip (do not roll or twist the O-ring).
8. Use a syringe filled with silicone grease and sparingly lubricate the O-ring with a thin film of grease. Avoid getting grease or fingerprints onto the optical window.
9. Remove the new optical cap from its container and align the cutout arrow on the Smart Cap with the matching guide on the probe body.
10. Slide and press the Smart Cap onto the probe body until the cap snaps in place.
Once the cap is installed, it should not be removed unless a new cap is required.
11. Place the probe in purified water to hydrate the Smart Cap before use for a minimum of 2 hours.
12. Turn ON the controller or plug in the probe's terminal connector and fully tighten the four captive screws.
13. Calibrate the probe and controller before reinstalling into the process.

25. MODBUS REMOTE CONTROL

Modbus is a request/response software protocol implemented on HI520 and intended for efficient and immediate remote industrial process control.

25.1. MODBUS WIRING

Follow the lead markings (+ positive / – negative) to ensure that output leads are correctly wired to the COMM position (Terminal 2) on the main board.

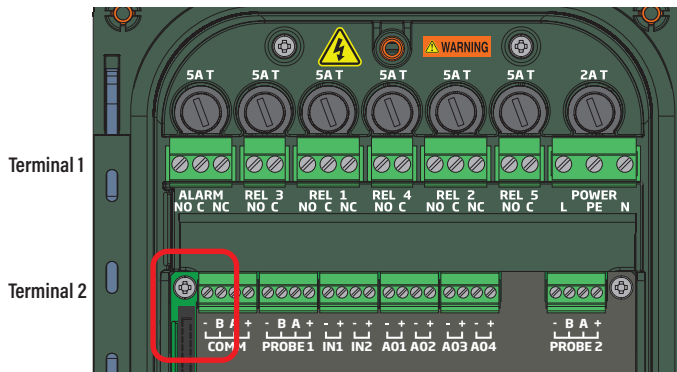

Note: See 4.2 Wiring for full wiring details



25.2. OPERATING MODES WHEN USING MODBUS

Mode Type	Scope	Description
Manual	Local control, controller operated manually	Controller operated manually. <i>Note:</i> Remote Control is not available.
Local Edit	Local edit of settings & parameters	Local edit of controller’s settings and parameters. <i>Note:</i> Remote Control is not available.
Calibration	System calibration	Allows for controller’s system calibration. <i>Note:</i> Remote Control is not available.
Remote Control	HI520 remote control mode	Remote operation is available. When not enabled, controller reverts to manual mode.
Remote View	View parameter & settings values	Remote Control Mode must be enabled. Use Modbus function codes to view or retrieve data. <i>Note:</i> Parameters cannot be updated in this mode.

Mode Type	Scope	Description
Remote Edit	View & change parameter and settings values	Remote Control Mode must be enabled. Value contained in the data field is outside range or not accepted as configurable value.
Remote Save	Saves data entered in Edit Mode	Remote Control Mode must be enabled. After editing/changing parameters, the HI520 is placed on Hold and data saved.
Init (Initialization)	Loads new parameter & settings values	Following a Remote Save, the controller automatically runs through an initialization procedure to ensure new data/parameters are being used.

Note: Ensure proper and safe system design and operation i.e. the use of operator presence systems or emergency stop buttons.

25.3. SETUP

- Press the  key to access the main menu.
- Press the   keys to navigate to General setup.
- Enable **Remote Control** option.
- Configure Communication Protocol parameters to match the Modbus server.

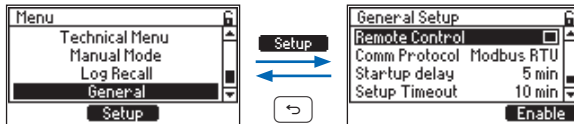

Refer to the [HI520 Dual-Channel Universal Process Controller Modbus Remote Control](https://manuals.hannainst.com/HI520) manual for full configuration details and protocol functions.

<https://manuals.hannainst.com/HI520>

26. TROUBLESHOOTING GUIDE

Symptom	Problem	Solution
Slow response / Excessive drift	Dirty pH electrode	Soak the tip in HI7061 Electrode cleaning solution for 30 minutes and then follow the pH cleaning procedure.
	Dirty EC probe	Remove and clean the sleeve. Make sure the rings on the probe are clean.
	Dirty DO probe	Remove the cap. Inspect, and clean or replace, if necessary.
Reading fluctuates up and down (noise)	Clogged/dirty pH electrode junction.	Clean the electrode.
	EC probe sleeve not properly inserted; air bubbles inside sleeve.	Make sure the sleeve is correctly placed. Tap the probe to remove air bubbles.
	DO probe electrolyte contains air bubbles	Remove the cap. Refill, tap and reinstall.
Controller fails to calibrate (or gives faulty readings)	Broken probe	Replace the probe.
Display shows the reading blinking	Dry membrane (or junction)	Soak electrode in HI70300 Storage solution for at least 30 minutes.
	EC reading is out of range	Remove and clean the sleeve. Make sure the rings on the probe are clean.
	DO reading is out of range	Remove the cap. Inspect, and clean or replace, if necessary. Stir or increase the flow rate.
Error messages displayed during calibration	Wrong (contaminated) buffer or standard solution	Check that calibration solution is correct and fresh.
	Dirty (broken) probe	Check the probe.

Note: ORP electrodes: gently polish the metal tip with a lightly abrasive paper, paying attention not to scratch the surface. Follow with a thorough wash.

Note: It is recommended to keep at least one spare electrode handy. When problems are not resolved with a simple maintenance procedure, change the probe and recalibrate.

27. APPLICATION CONFIGURATION

See below, a configuration example with Probes, RS-485 Modbus remote control, Input, Output and Analog Wiring.

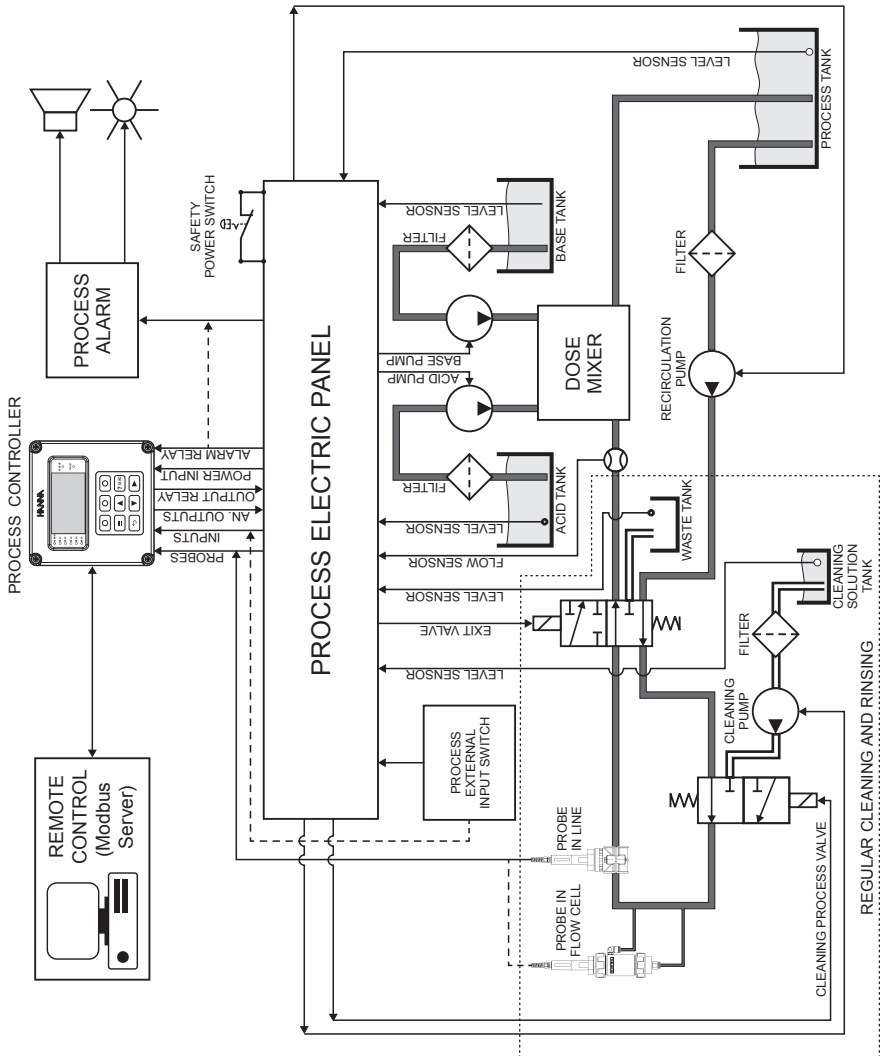

Figure 73: HI520 Configuration

28. ACCESSORIES

28.1. pH CALIBRATION SOLUTIONS

Ordering Information	Product Description	Quantity
HI7004M or HI7004L	4.01 pH buffer solution	230 or 500 mL
HI7006M or HI7006L	6.86 pH buffer solution	250 or 500 mL
HI7007M or HI7007L	7.01 pH buffer solution	230 or 500 mL
HI7009M or HI7009L	9.18 pH buffer solution	250 or 500 mL
HI7010M or HI7010L	10.00 pH buffer solution	230 or 500 mL

28.2. ORP SOLUTIONS

Ordering Information	Product Description	Quantity
HI7021M or HI7021L	Test solution, 240 mV	230 or 500 mL
HI7022M or HI7022L	ORP test solution, 470 mV	230 or 500 mL
HI7091L	Pretreatment reducing solution	500 mL + 14 g
HI7092M or HI7092L	Pretreatment oxidizing solution	250 or 500 mL

28.3. CONDUCTIVITY SOLUTIONS

Ordering Information	Product Description	Quantity
HI7030M or HI7030L	12880 $\mu\text{S}/\text{cm}$ standard solution	250 or 500 mL
HI7031M or HI7031L	1413 $\mu\text{S}/\text{cm}$ standard solution	230 or 500 mL
HI7033M or HI7033L	84 $\mu\text{S}/\text{cm}$ standard solution	230 or 500 mL
HI7034M or HI7034L	80000 $\mu\text{S}/\text{cm}$ standard solution	250 or 500 mL
HI7035M or HI7035L	111800 $\mu\text{S}/\text{cm}$ standard solution	230 or 500 mL
HI7037M or HI7037L	100 % NaCl sea water standard solution	250 or 500 mL
HI7039M or HI7039L	5000 $\mu\text{S}/\text{cm}$ standard solution	250 or 500 mL

28.4. DO SOLUTIONS & ACCESSORIES

Ordering Information	Product Description	Quantity
HI7040L	Zero oxygen solution set	500 mL + 12 g
HI7042B	Galvanic DO electrolyte solution	30 mL
HI731350	Plastic tip	25 pcs.
HI740226	5 mL graduated syringe	1 pc.
HI76409A/P	Replacement membrane	5 pcs.

28.5. ELECTRODE STORAGE SOLUTIONS

Ordering Information	Product Description	Quantity
HI70300M or HI70300L	Storage solution	230 or 500 mL
HI7082	3.5M KCl Electrolyte	4 \times 30 mL

28.6. ELECTRODE CLEANING SOLUTIONS

Ordering Information	Product Description	Quantity
HI7061M or HI7061L	General cleaning solution	230 or 500 mL
HI7073M or HI7073L	Protein cleaning solution	250 mL + 3 sachets or 500 mL + 6 sachets
HI7074M or HI7074L	Inorganic cleaning solution	250 or 500 mL
HI7077M or HI7077L	Oil & fat cleaning solution	250 or 500 mL

28.7. PATCH CABLES

Ordering Information	Product Description
HI76510-05	Patch cable, 5 m (16'5")
HI76510-10	Patch cable, 10 m (32'9")
HI76510-15	Patch cable, 15 m (49'2")
HI76510-25	Patch cable, 25 m (82')
HI76510-50	Patch cable, 50 m (164')

28.8. ELECTRODE HOLDERS

Ordering Information	Product Description
HI60501	PVC immersion electrode holder
HI60503	PVDF immersion electrode holder
HI60542	In-line electrode holder, direct pipe installation

Specifications

	Material		Temperature		Immersion length	Pressure
	Body	O-ring	Min.	Max.	Min. / Max.	Max.
HI60501	PVC	NBR	-10 °C (14 °F)	60 °C (140 °F)	10 cm / 69 cm (3.9" / 27.1")	N/A
HI60503	PVDF	NBR	-15 °C (5 °F)	100 °C (212 °F)		
HI60542	PVC	NBR	-10 °C (14 °F)	60 °C (140 °F)	N/A	8 bar (116 psi) at 25 °C (77 °F) 3 bar (43.5 psi) at 50 °C (122 °F)

Accessories

Ordering Information	Product Description	Quantity
HI60501-0	O-rings for HI60501 electrode holder	1 set
HI60501-2	PVC protective end cap, inside height 68 mm (2.6")	1 pc.
HI60503-2	PVDF protective end cap, inside height 68 mm (2.6")	1 pc.
HI605011	PVC mounting flange for HI60501 electrode holder	1 pc.

HI60501 PVC immersion electrode holder

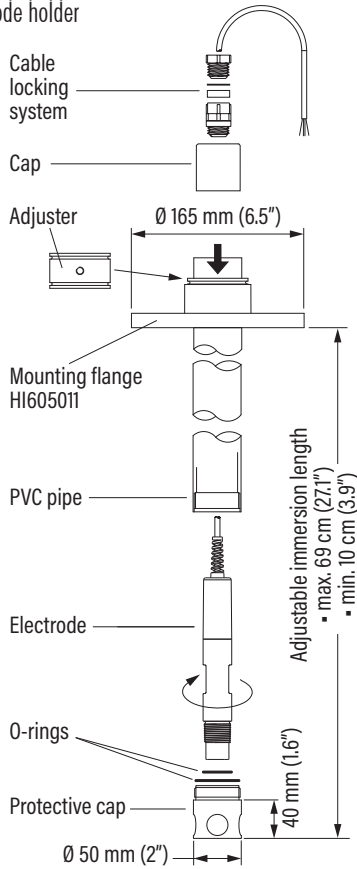

HI60542 In-line electrode holder, direct pipe installation

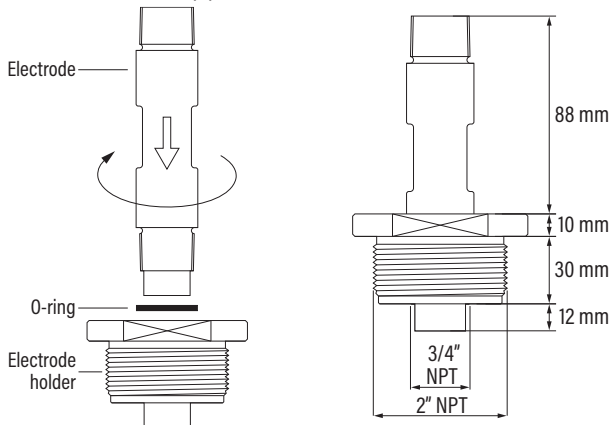

28.9. FLOW CELL SADDLE AND FITTINGS

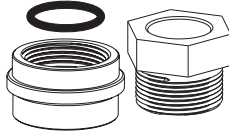
BL120-400Flow cell
probe adapter kit**BL120-500**

Probe fitting kit

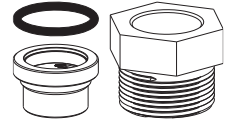
**BL120-401**

Flow cell valve

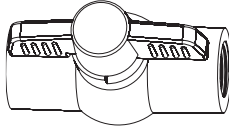
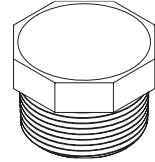
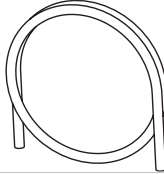
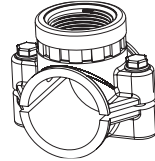
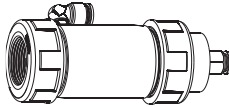
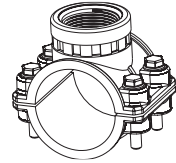
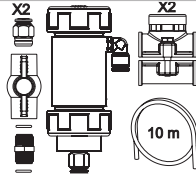
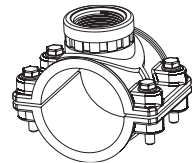
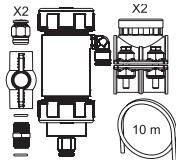
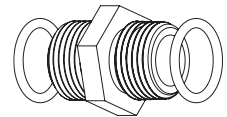
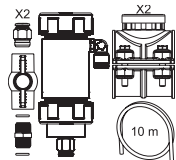
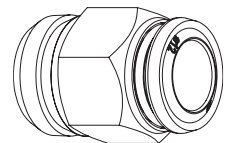
**BL120-501**Protective saddle cap,
1 1/4" thread**BL120-402**Flow cell tubing
(10 m)**BL120-550**Probe saddle
for Ø 50 mm pipe,
1 1/4" thread**BL120-410**Flow cell for
BL120, BL121,
BL122, BL123**BL120-563**Probe saddle
for Ø 63 mm pipe,
1 1/4" thread**BL120-450**Flow cell kit for
Ø 50 mm pipe**BL120-575**Probe saddle
for Ø 75 mm pipe,
1 1/4" thread**BL120-463**Flow cell kit for
Ø 63 mm pipe**BL120-601**Plastic nipple
2 x 1/2"
with O-rings**BL120-475**Flow cell kit for
Ø 75 mm pipe**BL120-602**Metal nipple
12 x 1/2" (2 pcs.)

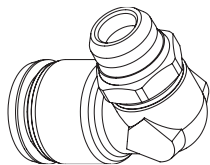
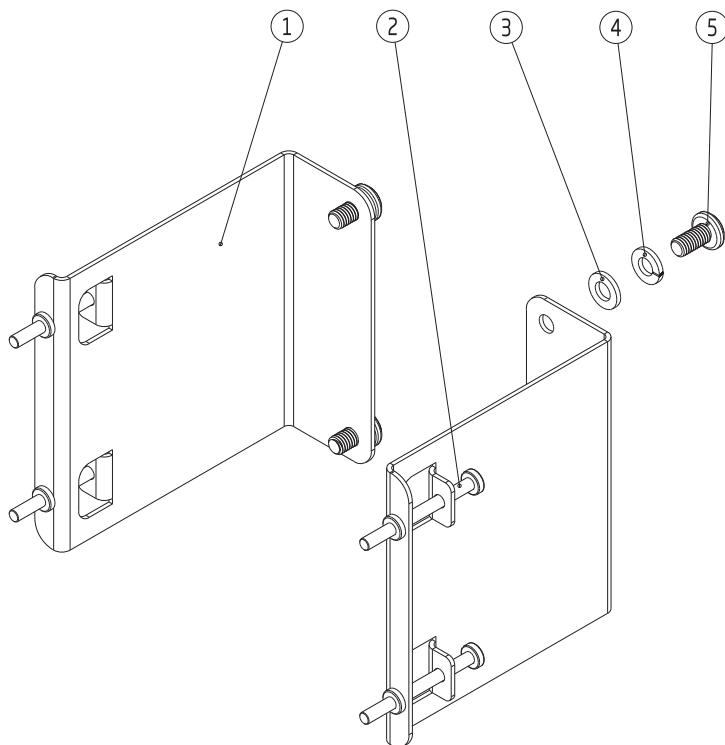
BL120-603Elbow
for glass flow cell**BL120-604**O-rings
for glass flow cell**28.10. MOUNTING KIT ACCESSORIES****HI510-01 Panel-Mount Kit**

Label	Product Description	Supplied Quantity
1	Panel bracket	2 pcs.
2	M4 × 45 screw, Phillips head	4 pcs.
3	Plain washer for M6 screw	4 pcs.
4	Spring washer, M6	4 pcs.
5	M6 × 12 mm screw (DIN7985)	4 pcs.

HI510-02 Wall-Mount Kit

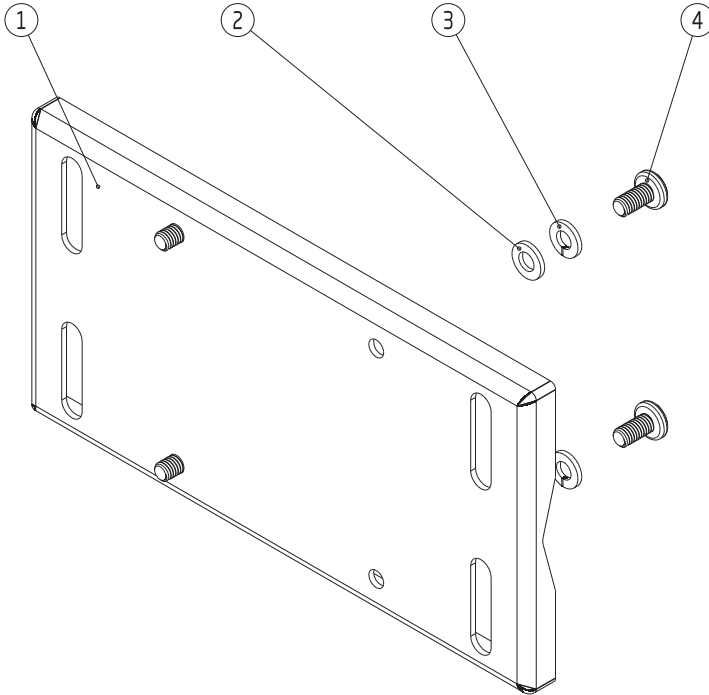

Label	Product Description	Supplied Quantity
1	Zinc plated, zinc case holder	1 pc.
2	Plain washer for M6 screw	4 pcs.
3	Spring washer, M6	4 pcs.
4	M6 × 12 mm screw (DIN7985)	4 pcs.

HI510-03 Pipe-Mount Kit

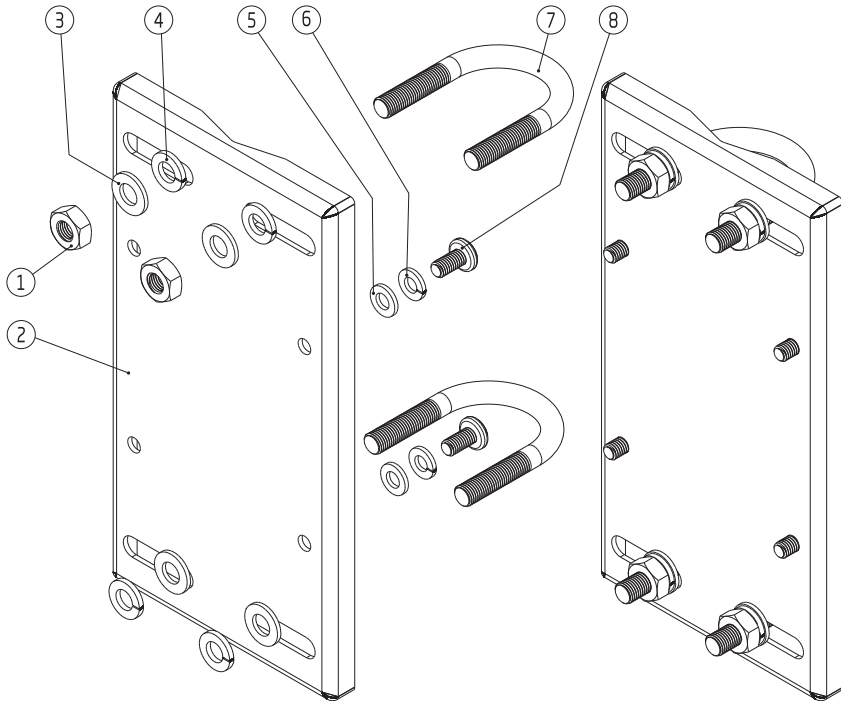

Label	Product Description	Supplied Quantity
1	Hex nut, M8	4 pcs.
2	Zinc plated, zinc case holder	1 pcs.
3	Plain washer for M8 screw	4 pcs.
4	Spring washer, M8	4 pcs.
5	Plain washer for M6 screw	4 pcs.
6	Spring washer, M6	4 pcs.
7	U-Bolt 1"	2 pcs.
	U-Bolt 1½"	2 pcs.
	U-Bolt 2½"	2 pcs.
8	M6 × 12 mm screw (DIN 7985)	4 pcs.

HI605101 Rail Mount Kit

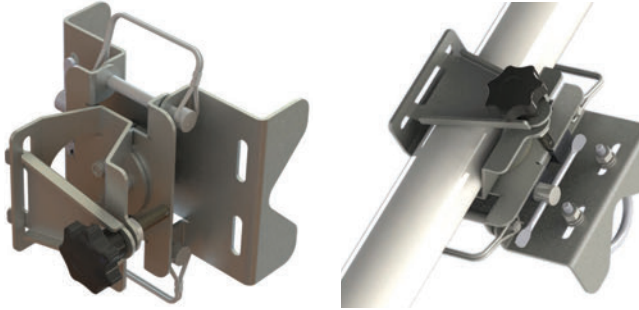

29. ANNEX

29.1. BUFFER VALUES AT VARIOUS TEMPERATURES

Temperature has an effect on pH. The calibration buffer solutions are affected by temperature. During two- or three-point buffer calibration, the controller utilizes auto buffer recognition. The following chart is for reference only.

Temperature		pH Values				
°C	°F	4.01	6.86	7.01	9.18	10.01
0	32	4.01	6.98	7.13	9.46	10.32
5	41	4.00	6.95	7.10	9.39	10.25
10	50	4.00	6.92	7.07	9.33	10.18
15	59	4.00	6.90	7.05	9.27	10.12
20	68	4.00	6.88	7.03	9.22	10.06
25	77	4.01	6.86	7.01	9.18	10.01
30	86	4.02	6.85	7.00	9.14	9.96
35	95	4.03	6.84	6.99	9.11	9.92
40	104	4.04	6.84	6.98	9.07	9.88
45	113	4.05	6.83	6.98	9.04	9.85
50	122	4.06	6.83	6.98	9.01	9.82
55	131	4.08	6.84	6.98	8.99	9.79
60	140	4.09	6.84	6.98	8.97	9.77
65	149	4.11	6.84	6.99	8.95	9.76
70	158	4.12	6.85	6.99	8.93	9.75

For instance, if the buffer temperature is 25 °C, the display should show 4.01, 7.01, or 10.01 pH for 4, 7, or 10 pH buffers, respectively.

At 20 °C, the display should show 4.00, 7.03, or 10.06 pH.

At 50 °C, the display should show 4.06, 6.98, or 9.82 pH.

29.2. GLOSSARY

cleaning	automatic procedure to stop control, clean the electrode and then activate control again
data acquisition	conversion of analog signals received from the probe sensor to digital representations that can be processed by a computer
dead band	an area where the absolute value of the error between Set point and process value is considered 0
dead band gain	a coefficient applied to PID integrative term in the Dead Band area
deviation	an interval aligned with Set point value, where control output can take values from 0 % to 100 %. It is measured in process-value units.
fail safe alarm	Signaling of the alarm by de-energizing the alarm relay instead of energizing it. Protects against power failures and interruptions of the alarm relay external wires.
hysteresis	interval that must be exceeded by the controlled magnitude in the opposite direction after having activated a relay, before deactivating it, in order to avoid uninterrupted relay activation or deactivation
minimum On time	the time that control output is minimum On, necessary to protect elements that are driven
overtime	a safety parameter provided to set the maximum continuous time control is running at it's maximum value
potential matching pin	is a titanium which must be immersed into the measured fluid. It is used together with a differential input to avoid damage of the reference electrode due to ground loop current.
sequential control	control-loop system whereby users have the option to run channel control independently or configure to be triggered sequentially
set point	desired value for the controlled parameter
solution compensation	technique for compensating the differences on the pH of the solution under measurement when its temperature varies
threshold	value above / below which a control or alarm relay is activated or deactivated
trigger	an event or command that acts like a mechanical trigger in initiating a process

29.3. LIST OF FIGURES

Figure 1: Front Panel & Keypad Description	page 11
Figure 2: Display Description	page 12
Figure 3: Side View: USB-C Port & Venting Element	page 14
Figure 4: Wall-Mount Panel, Slots Dimensions	page 17
Figure 5: Wall-Mount Panel Thickness, Mounting Bolts & Slots Dimensions	page 18
Figure 6: HI520 Controller Fastened to Wall-Mount Panel	page 18
Figure 7: Wall-Mount Schematic	page 19
Figure 8: Panel Mount, Inside Depth	page 20
Figure 9: Panel Mount Cutout	page 20
Figure 10: Panel-Mount Schematic	page 21
Figure 11: Panel-Mount Steps, Parts (A) (B) (C)	page 22
Figure 12: Pipe-Mount Schematic	page 23
Figure 13: Vertical & Horizontal Pipe Mount	page 24
Figure 14: Conduit Openings	page 25
Figure 15: Exposed Cable Gland Schematic	page 25
Figure 16: HI520 Enclosure Opened	page 26
Figure 17: Hinged Front Panel	page 26
Figure 18: Signal Board & Output	page 27
Figure 19: Input Values	page 28
Figure 20: Connecting Alarm Circuit Between FS • C & COM Terminals	page 29
Figure 21: Probes Wiring	page 30
Figure 22: Event logging example	page 72
Figure 23: On/Off Control Block Algorithm	page 85
Figure 24: On/Off Control, High /Low Control Mode	page 86
Figure 25: General On/Off Control	page 86
Figure 26: On/Off Control with Hysteresis	page 87
Figure 27: On/Off Control, Overtime Control Action	page 87
Figure 28: On/Off Control, Minimum On Time	page 87
Figure 29: Proportional Control Block	page 89
Figure 30: Control Low with Relay On, Set Point and Deviation	page 90
Figure 31: Control High with Relay On, Set Point and Deviation	page 90
Figure 32: Proportional Control, Relay Out - Control Mode High/Low	page 90
Figure 33: Proportional Control, Analog Out - Control Mode High and Low	page 91
Figure 34: Proportional Control, Relay Out - Proportional Control Mode High, Overtime	page 91
Figure 35: Proportional Control, Relay Out, Proportional Control Mode High, Min. On Time	page 91
Figure 36: Proportional Control, Relay Out, Proportional Control Mode Low with Dead Band	page 92

Figure 37: PID Control Block.....	page 94
Figure 38: Proportional Action by Means of Proportional Band	page 94
Figure 39: Controller Structure Representation	page 95
Figure 40: Proportional Function with pH Probe Connected	page 96
Figure 41: Derivative Function with pH Probe Connected.....	page 96
Figure 42: Tuning PID Parameters, Dosing an Alkaline Solution to a Weak Acid	page 98
Figure 43: PID Control Mode Low, Relay & Analog Out	page 98
Figure 44: PID Control Mode Low, Relay Out with Minimum On Time.....	page 99
Figure 45: PID Control Mode Low, Relay Out with 0 % Dead Band Gain	page 99
Figure 46: PID Control Mode Low, Relay Out with 50 % Dead Band Gain.....	page 99
Figure 47: Cleaning Control & Sequencer Block.....	page 101
Figure 48: Cleaning Algorithm, Simple Cleaning.....	page 103
Figure 49: Cleaning Algorithm, Advanced Cleaning	page 103
Figure 50: Cleaning Trigger, External Input	page 104
Figure 51: Cleaning Trigger, Internal Timer	page 104
Figure 52: Cleaning Trigger, Internal Schedule	page 104
Figure 53: Cleaning Trigger, Operator Intervention.....	page 104
Figure 54: Cleaning Trigger, External Input & Internal Timer	page 105
Figure 55: End Cleaning, Stop Sequences	page 105
Figure 56: End Cleaning, Suspend Condition	page 106
Figure 57: End Cleaning, Stop Condition	page 106
Figure 58: HI1006-18zz industrial pH probe with attached cable	page 114
Figure 59: HI1006-1800 industrial pH probe with DIN connector	page 114
Figure 60: HI1026-1803 pH probe for specific meat applications	page 115
Figure 61: HI1126-1805 pH probe for general food applications.....	page 115
Figure 62: HI2004-18zz industrial ORP with attached cable	page 115
Figure 63: HI2004-1800 industrial ORP with DIN connector	page 115
Figure 64: HI7630-28zz two-electrode EC probe with attached cable.....	page 126
Figure 65: HI7630-2800 two-electrode EC probe with DIN connector.....	page 126
Figure 66: HI7630-48zz four-ring EC probe with attached cable	page 126
Figure 67: HI7630-4800 four-ring EC probe with DIN connector.....	page 127
Figure 68: HI7640-18zz galvanic DO probe with attached cable.....	page 139
Figure 69: HI7640-1800 galvanic DO probe with DIN connector.....	page 139
Figure 70: Smart cap detail (HI7640-58 industrial optical DO).....	page 148
Figure 71: HI7640-58ZZ optical DO with attached cable	page 149
Figure 72: HI7640-5800 optical DO with DIN connector.....	page 149
Figure 73: HI520 Configuration	page 161

CERTIFICATION

All Hanna Instruments conform to the **CE European Directives** and **UK standards**.



Disposal of Electrical & Electronic Equipment. The product should not be treated as household waste. Instead hand it over to the appropriate collection point for the recycling of electrical and electronic equipment which will conserve natural resources.

Ensuring proper product disposal prevents potential negative consequences for the environment and human health. For more information, contact your city, your local household waste disposal service, or the place of purchase.

RECOMMENDATIONS FOR USERS

Before using this product, make sure it is entirely suitable for your specific application and for the environment in which it is used. Any variation introduced by the user to the supplied equipment may degrade the meter's performance. For yours and the meter's safety do not use or store the meter in hazardous environments.

WARRANTY

HI520 is warranted for two years against defects in workmanship and materials when used for its intended purpose and maintained according to instructions. Electrodes and probes are warranted for a period of six months. This warranty is limited to repair or replacement free of charge. Damage due to accidents, misuse, tampering or lack of prescribed maintenance is not covered.

If service is required, contact your local Hanna Instruments office. If under warranty, report the model number, date of purchase, serial number (see engraved on the back of the meter) and the nature of the problem. If the repair is not covered by the warranty, you will be notified of the charges incurred. If the meter is to be returned to Hanna Instruments, first obtain a Returned Goods Authorization number from the Technical Service department and then send it with shipping costs prepaid. When shipping any meter, make sure it is properly packed for complete protection.